

**Rectangular
wooden pools**
Double pine coping
Composite coping



INSTALLATION AND OPERATING INSTRUCTIONS

to be read carefully and kept for future reference

1. WOOD, A NATURAL MATERIAL	4
1.1 Colour variations	4
1.2 Resin beads.....	4
1.3 Salt stains	4
1.4 Greying	4
1.5 Splitting and cracking	4
1.6 Knots.....	5
1.7 Surface mould	5
1.8 Joined wood.....	5
1.9 Curved wood	5
2. FOREWORD.....	6
3. STORAGE & ASSEMBLY TIMES.....	6
3.1 Storage.....	6
3.2 Above-ground kit	6
3.3 Safety	7
4. QUICK OVERVIEW	7
4.1 Tools.....	7
4.2 Time required	7
5. EXCAVATION	8
5.1 Dimensions of the excavation and concrete slab.....	9
6. ASSEMBLY OF THE METALLIC STRUCTURE	10
6.1 The metallic structure.....	12
7. POURING THE CONCRETE SLAB	13
8. ASSEMBLING THE WALLS	14
9. THE WALLS (CONTD) & DRESSING THE POSTS	16
10. MOUNTING THE COPING SUPPORT BRACKETS.....	18
11. INSTALLING THE METAL FITTINGS.....	20
12. MOUNTING THE LINER LOCKING TRACK	21
13. WALL FINISHINGS.....	22
14. INSTALLATION OF THE POOL FITTINGS	22
14.1 Simmers	23
14.2 Throughwall flanges	24
15. FITTING THE UNDERLAY, LINER & FILLING THE POOL	24
15.1 The underlay.....	24
15.2 The liner	24

16. THE FILTRATION GROUP	25
16.1 Installation	25
16.1.1 Precautions and advice.....	26
16.2 Mounting the rigid descending pipes	27
16.3 Assembly of the filter	29
16.4 Collector and pump/ filter module.....	31
16.5 Pipe connections	31
16.6 Filling the water circuit.....	33
16.7 Filling the pool and cutting the liner.....	33
16.8 The underwater light (Odyssey model).....	34
17. COPING.....	34
17.1 Installation of the double pine coping - Weva.....	34
17.2 Installation of the composite coping - Odyssey	35
18. LADDERS	37
19. COMMISSIONING AND OPERATING RECOMMENDATIONS	38
19.1 Filter and valve operation	38
19.2 Length of the filtration cyclen	38
19.3 Cleaning the pre-filter & filter backwash	39
19.3.1 Pre-filter	39
19.3.2 Filter.....	39
19.3.3 Dechlorinator (Odyssey model).....	40
20. OPERATION AND MAINTENANCE	40
20.1 Winterizing the pool.....	41
20.1.1 Winterizing the hydraulic installation.....	41
20.2 Water treatment.....	41
20.3 Hygiene.....	42
21. GUARANTEES.....	42
21.1 Wooden components:	42
21.2 Accessories.....	42
22. DO NOT PLAY WITH SAFETY !!!	45
23. APPENDICES - EXPLODED VIEWS.....	46



1. WOOD, A NATURAL MATERIAL

Being a natural material, wood will have some imperfections. These are normal and have no impact on the service life of the product.

A certain number are superficial and do not fall within the scope of the guarantees.

1.1 Colour variations

Colour variations are common to every species of wood. Treatment brings them out because the depth of penetration of the product depends on the wood density and grain. Weathering of wood outdoors will significantly attenuate these colour variations.



1.2 Resin beads

When resinous wood species are autoclaved, the alternating pressure and vacuum can cause sticky residue to rise to the surface. To remove it, scrape it carefully with an appropriate tool, being careful not to touch the wood. Turpentine spirits could also be effective, but could stain the wood if too much is applied.

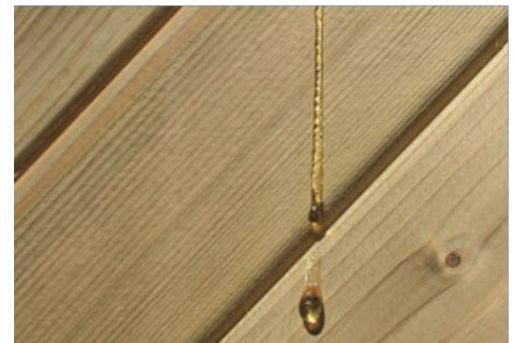

1.3 Salt stains

Small green stains are frequently found on the surface of autoclaved wood. These can be removed with light sanding. If left untreated, this colour will disappear over time.

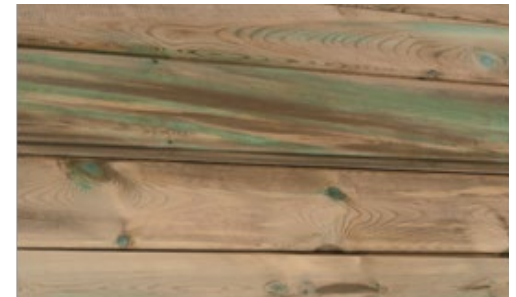

1.4 Greying

Wood exposed to the sun and the moon is susceptible to greying. Some of the wood could already be greyed due to the storage conditions of the various elements of the structure.

This is a natural phenomenon that has no impact on the structural integrity of the product. The colour of the whole structure will even out after a few months of exposure..



1.5 Splitting and cracking

Wood expands and contracts when exposed to variations in humidity and temperature. As it dries, wood contracts unevenly resulting in the appearance of cracks. While these can seem to be cause for concern, they have no impact on the mechanical properties of the product and therefore do not fall within the scope of the guarantee.

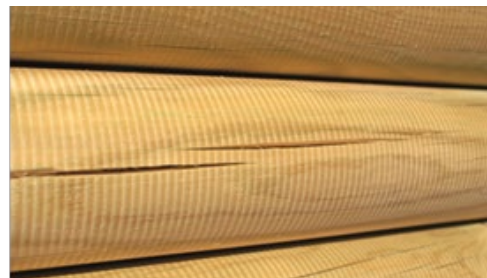

1.6 Knots

Knots mark the places where branches were attached. The quantity and size depends on the species of wood and the sorting process. For outdoor installations, small adherent knots are acceptable.



1.7 Surface mould

Mould, caused by microscopic fungi, can grow on wood, particularly on resinous species, on which the growth can appear as "blueing". It is a surface phenomenon, exacerbated by heat, humidity and inadequate aeration and is characterised by stains ranging from light to dark blue. They can be removed by wiping the surface.

Remember that class IV treated wood is protected against attack by fungi that could destroy the physical and mechanical properties of the wood



1.8 Joined wood

To ensure the highest quality in the selection of our wood, it is sorted meticulously before planing. Sections that features defects on both sides are removed and the wood is then joined together (see image).

This is no way penalises the mechanical properties of the wood.

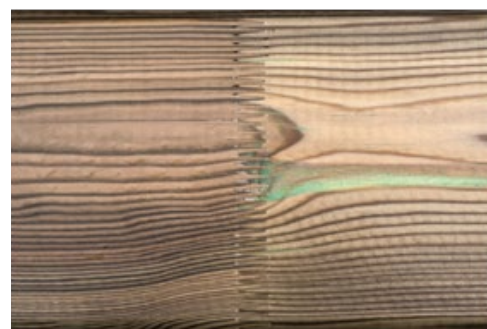

1.9 Curved wood

Due to the constant pressure exerted by the water, the walls of the pool may curve slightly over time.

This phenomenon, attributable to the natural elasticity of wood, will stabilise of its own accord and in no way would lead to failure of the wooden slats.

It is not a defect, and would not constitute grounds for a guarantee claim..

2. FOREWORD

Congratulations on acquiring your pool. We have taken great care with the design and manufacture of your pool to provide you with a top quality product.

The wood used to make the various elements (interlocking walls, coping, ladder, etc.) was carefully selected. Outdoors, these wooden elements are subject to constant weathering: contact with the ground, temperature variations, exposure to sunlight, rain and frost, insect attack, etc. The wood's ability to withstand this aggression depends on the origin of the wood and the method used to treat it.

For this reason, we choose pine from extensive, sustainably managed forests in northern Europe. Why do we insist on this? Because the more rigorous climates above the 57th parallel favour very slow tree growth, making the wood stronger and more resilient.

The wood is autoclaved, this involves subjecting the wood alternately to pressure and vacuum in order to drive the treatment chemicals into the heart of the wood as opposed to other more superficial treatment techniques such as soaking.

Class IV treated wood in contact with the ground is immune to insect attack and rotting caused by humidity. Autoclave treatment is guaranteed 10 years, in accordance with standards currently in effect.

The pool coping is made of either composite slats or grooved pine planks, depending on the model selected.

Wood is a living material, variations in temperature and humidity can cause it to expand or contract so take care to follow the storage and assembly instructions concerning the wooden structure. Similarly, prolonged exposure to UV light can cause wood to grey. These are natural phenomena that in no way effect the service life of the products.

Do not apply any product to the wood (for example: lazure, micro-porous products, etc.).

3. STORAGE & ASSEMBLY TIMES

We shall now explain how to assemble your pool, but first some instructions before you begin.

Please read these instructions carefully, this will allow you to prepare each stage to achieve optimum efficiency. Please keep these instructions for future reference.

You should take the time to go through the components using the nomenclature page enclosed with the accessories kit and make sure that no items are missing.

Please retain the following documents;

- the production sheets for the various kits
- proofs of purchase

3.1 Storage

If you do not intend to assemble your pool immediately, you should store it without opening it, in a well ventilated room, or failing this, in an area protected from humidity and sunlight. Once the pallets are undone, the kit must be assembled within 24 hours. Once work has begun, try to avoid leaving the structure exposed to significant climatic variations that could cause the wood to "work" too quickly. This could lead to deformations that could render the item unusable. By preference, the wooden structure should be assembled in one go on a day that is not too hot. The liner or PVC waterproofing membrane should be stored at a minimum of 20°C for at least 24 hours before it is fitted. This is to render the liner more supple and thus facilitate fitting. The liner should only be fitted if the ambient temperature is higher than 20 °C.

3.2 Above-ground kit

The kit delivered is intended for installation above-ground. If the pool is to be installed partially or entirely in-ground, additional measures will need to be taken :

- If the ground is not level, dig into the slope, never backfill under the pool.
- Take care to ensure sufficient drainage adapted to the terrain around the periphery of the concrete

slab.

- Cover the portion of the wall that is underground with a protective layer of foundation grade plastic film.
- For backfilling around the pool use stabilised sand (mortar 150 kg/m³). (The materials necessary to implement these measures are not included in the kit).

3.3 Safety

- Your installation should comply with the standard C15-100. Notably, the electrical supply of the pump should be protected by a 30mA differential circuit breaker. (Wiring should be carried out by a qualified professional).
- The kit provided will allow installation of the filtration system 3.5 m from the pool, this is in line with pool safety standards.

We recommend that you secure access to the pool using one of the protective measures set out in the pool safety standards NF P 90-306, 307, 308 & 309 that is: Barriers - Alarms - Safety covers - Shelters.

- Children should only use the pool under the supervision of an adult.
- Remember to remove the exterior wooden ladder while the pool is not in use to prevent unsupervised access to the pool.
- This pool is intended for private use only.
- Do not install the pool beneath electrical wires.

4. QUICK OVERVIEW

- Excavation
- Assembly of the metal structure
- Pouring the concrete slab
- The wooden structure
- The filtration group

4.1 Tools

- decameter
- rope,
- tube wrench (13 and 17),
- mallet,
- screw gun (with a torx, pozi bit),
- Stanley knife,
- metal saw,
- big spirit level,
- flat head screw driver,
- cross head screw driver,
- bolt cutters,
- sand paper,
- file,
- excavation equipment

4.2 Time required

Excavation : **1 TO 2 DAYS (DEPENDING ON THE MATERIALS USED)**

Metallic structure: **1 DAY (WITH 2 PEOPLE)**

Pouring the slab: **1 TO 2 DAYS (WITH 2 PEOPLE DEPENDING ON THE MATERIALS USED)**

Wooden structure and filtration: **2 TO 3 DAYS (WITH 2 PEOPLE - THE TIME INDICATED DOES NOT INCLUDE THE CONCRETE CURING TIME)**

Curing of the concrete slab before filling the pool with water: **21 DAYS (3 WEEKS)**

5. EXCAVATION

- ❗ Avoid siting your pool beneath trees or electrical lines.
- ❗ Orient the pool such that the skimmers face into prevailing winds.

After determining the ideal position for your pool, start with the excavation required to accommodate the concrete slab that will form the base of your pool. In *Figure 1*, identify those dimensions that correspond to your pool.

Never backfill under the pool to achieve a level surface, always dig down so that your pool rests on a stable, level surface.

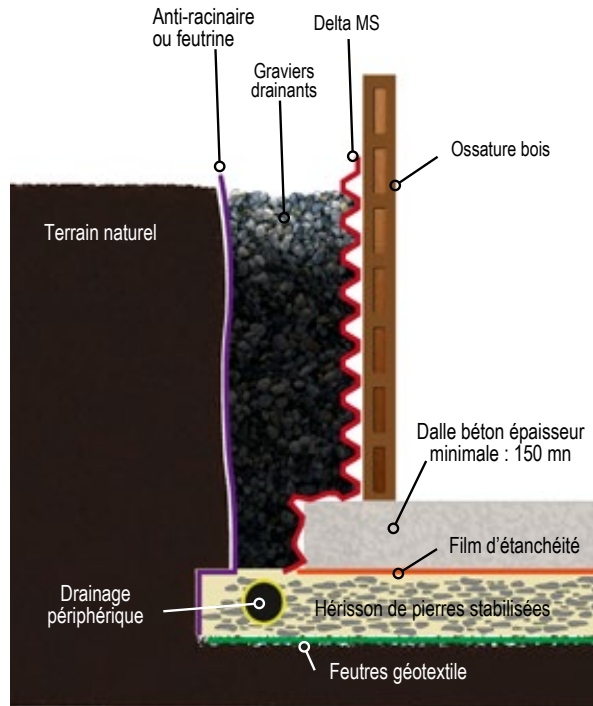

Excavation

The Delta MS membrane allows ventilation of the pool's wooden structure. Ventilation is necessary to prevent rotting of the wood.

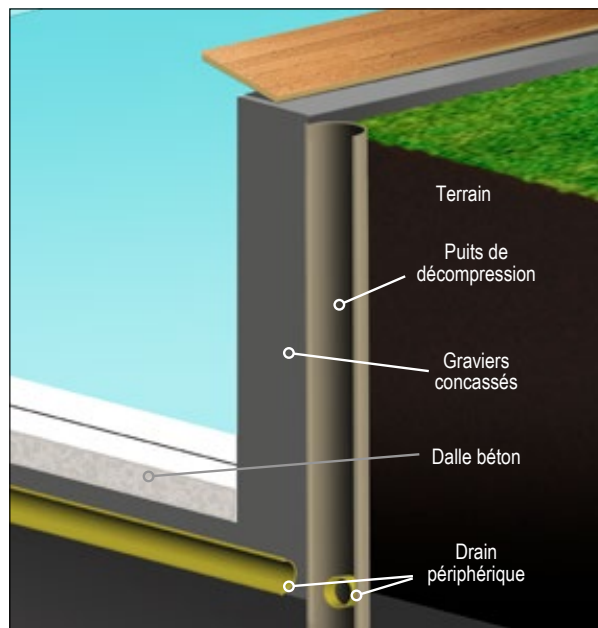

Drainage

Ensure that there is adequate peripheral drainage, especially if the pool is to be installed in-ground.

5.1 Dimensions of the excavation and concrete slab

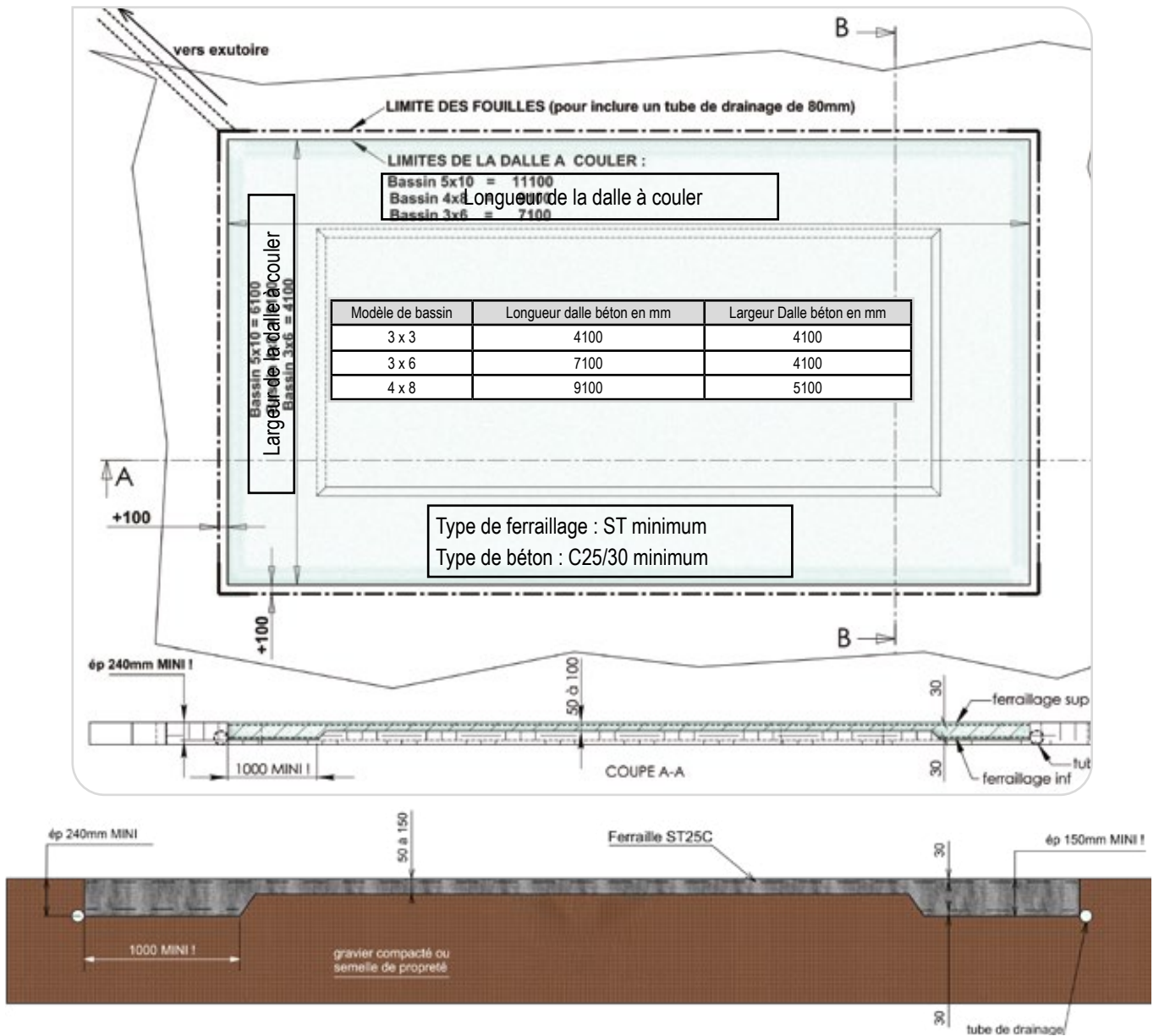

Figure 1 – dimensions of the excavation and concrete slab

Note that the excavation is deeper around the periphery in order to accommodate the reinforcing metallic structure. (Figure 2)

By deepening the excavation around the edges only, you minimise the total volume of concrete required to pour the slab.

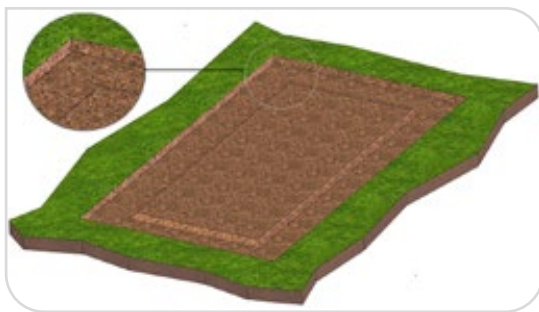

Figure 2 – Excavation around the periphery



Figure 3 – Rebar

The bottom of the excavation should be perfectly level to facilitate installation of the metallic structure. (Figure 3) (either add a layer of compacted gravel or pour a rough layer of concrete). Lay rebar mesh over this section (Figure 3).

6. ASSEMBLY OF THE METALLIC STRUCTURE

The metallic structure comprises posts joined together at the top and the bottom with flat bars (*Figure 4*). Observe how these parts overlap to ensure correct positioning of the structure. The top links should be dismantled once the slab has been poured.

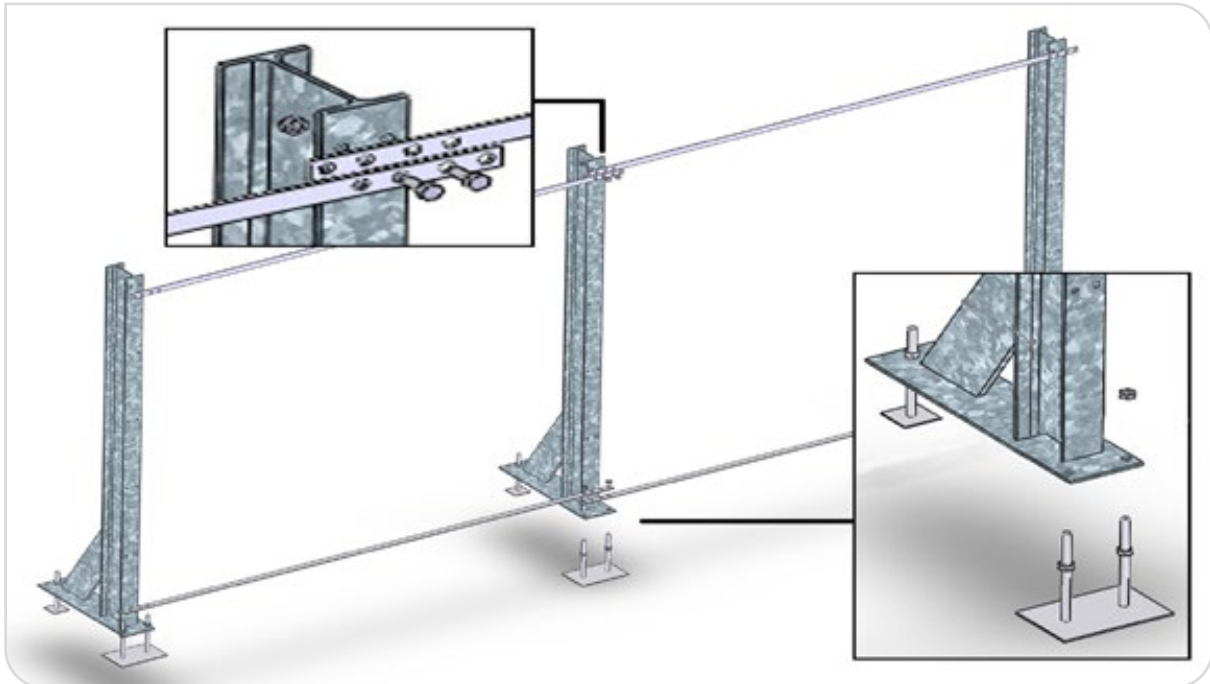

Figure 4 – Metallic structure



Figure 5 – Jacks

After correctly positioning the first layer of rebar (*Figure 3*) set out the metallic posts required to assemble your pool (*Figure 8*). Make sure that you fit them with jacks first (*Figure 4*). These posts are joined together at the bottom with flat bars fastened by two screws (bag A).

The distance between the each post is determined by the length of the flat bars.

The flat bars features 4 holes at each end.

The upper and lower connection bars are identical.

Around the base, the outer holes are used (*Figure 4*) while the inner holes are used on bars around the top of the structure (*Figure 6*).

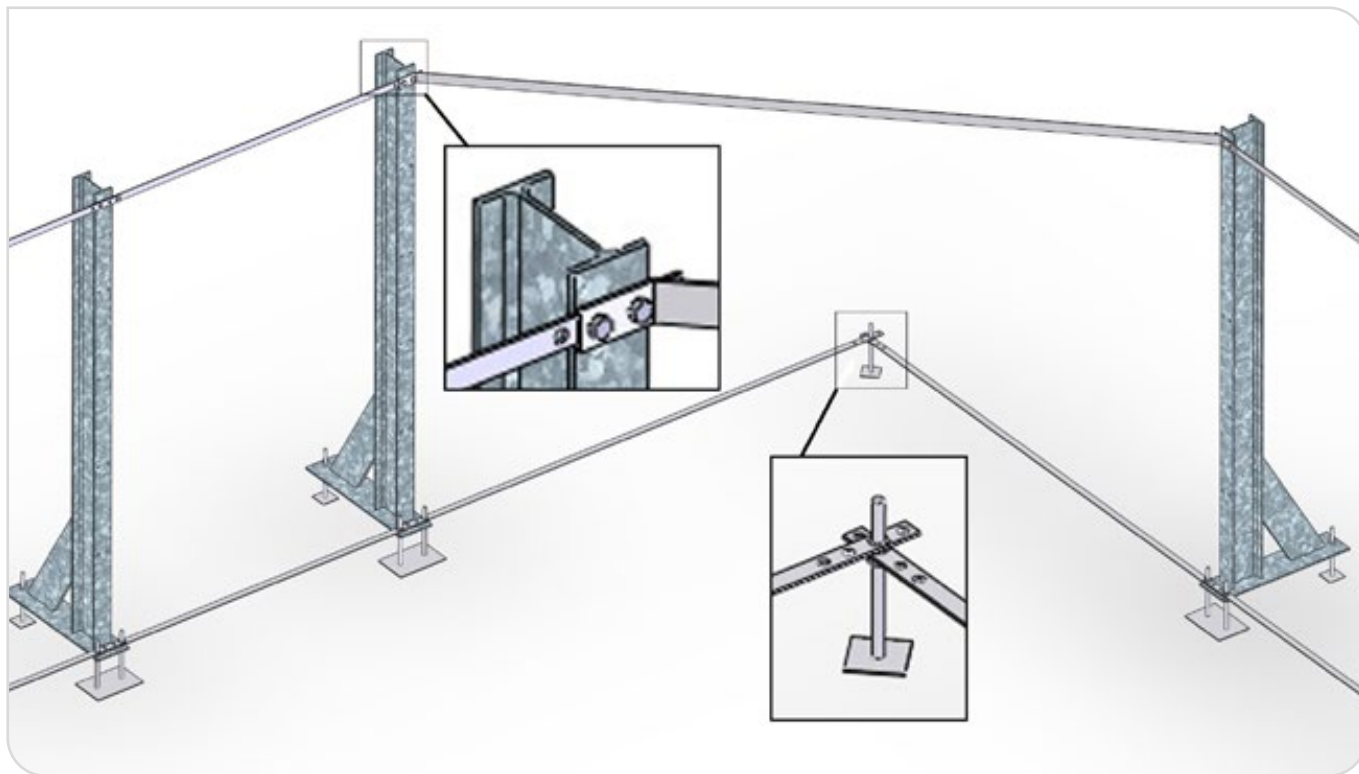
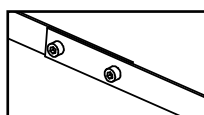

Figure 6 – Top and bottom bars



Depending on the version, the flat metallic bars are delivered as two separate sections to be bolted together.

Once the metallic structure has been assembled, adjust the position of the posts carefully and check :

- that the posts are level, straight and perfectly aligned.
- that the pool diagonals measured at the axis of the corner jacks are equal (*Figure 8*).

! For pools 1.20 m deep, the slab thickness should be approx 350 mm, disregard the +/- 40 mm measurement. The measurement before adjustment, 90 mm, is unchanged

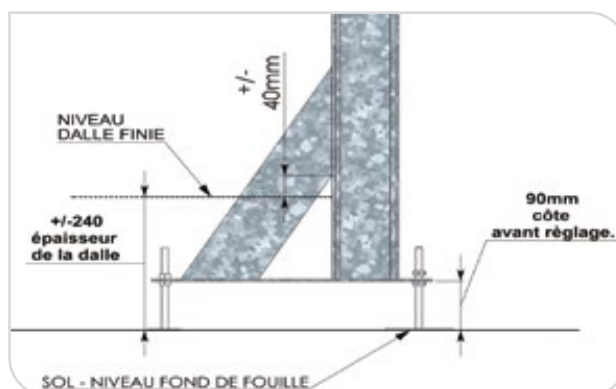

Figure 7 – Detail of the jack

! Take particular care during this stage of the assembly, it will impact subsequent phases and determine the quality of the pool finish.

6.1 The metallic structure

! Once the structure has been assembled, make sure that the diagonals are equal in length. Check that the posts are level and straight. Check that the height is correct.

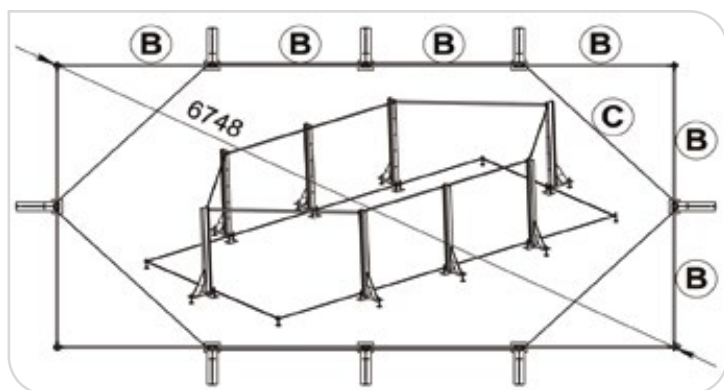

Figure 8 – Metallic structure - pool 3 x 6

A corresponds to a flat bar with an interaxial distance of 1m.

B corresponds to a flat bar with an interaxial distance of 1.5m

C corresponds to a flat bar for top corners

At the bottom corners, these flat bars are joined together by an AR type jack (Detail [Figure 6](#))

Table detailing the layout of the flat bars along the pool length and width for the various pool models.

Pool model	Diagonal in mm	Layout of the flat bars along each length	Layout of the flat bars along each width
3 x 3	4282	B / B	B / B
3 x 6	6748	B / B / B / B	B / B
4 x 8	8984	B / B / A / A / B / B	B / A / B

7. POURING THE CONCRETE SLAB

- ❗ Encase the base of the metal posts with a small amount of concrete before pouring the rest of the slab, this will help prevent deformation of the metallic structure (*Figure 10*).
- ❗ See *Figure 7* and *Figure 11* to determine the correct height of the concrete slab with respect to the posts.
- ❗ The finish of the concrete slab will determine the correct seating of the walls as well as the quality of the pool floor.

Position the top layer of rebar (second layer) over the entire surface of the excavation before pouring the concrete.

Once laid, the metal trellis should cover the whole surface (lay the trellis such that it is set 3 to 5 cm back from the edge around the entire periphery). Some cutting around the posts will be necessary (*Figure 10*). Bars should be allowed to overlap and should be connected together.

While pouring the slab, make sure that the upper rebar mesh is encased to the correct depth in the concrete.(minimum 3 cm)

Level the surface and smooth it as carefully as possible in order to minimise protrusions and asperities that will have to be corrected later.

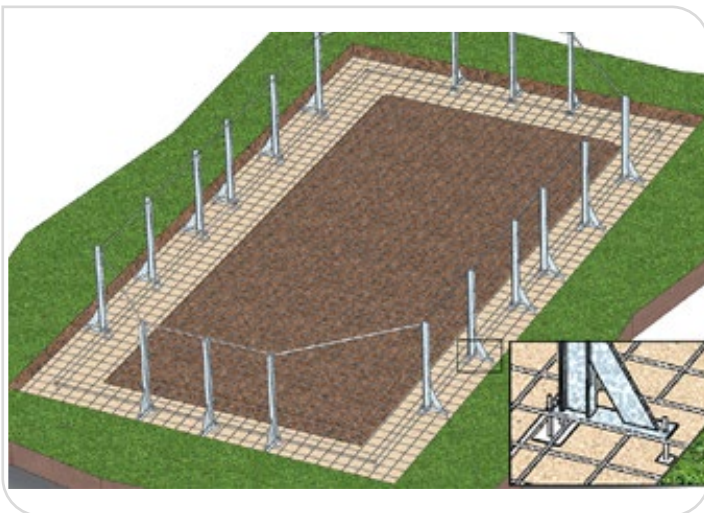

Figure 9 – Position of the metallic posts

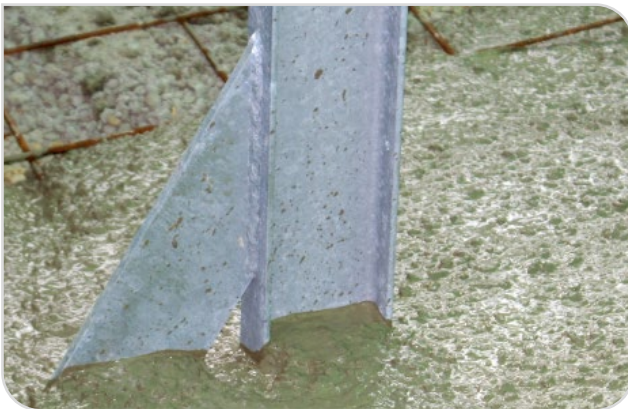

Figure 11 – Detail of the metallic posts

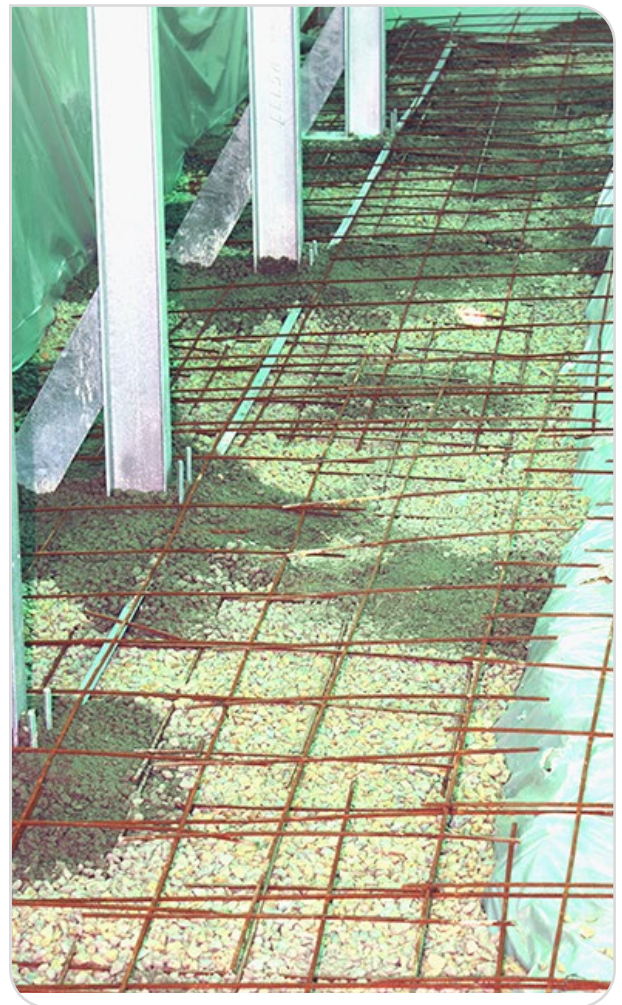

Figure 10 – Trimming around the posts

8. ASSEMBLING THE WALLS

- ! Before starting to assemble the wooden walls, make sure that the finish of the concrete slab is perfectly smooth and level. Any unevenness will be accentuated and more noticeable once the pool has been filled with water. If necessary, correct defects by sanding or resurfacing.
- ! Assembly of the wooden structure may begin 2 to 3 days after the slab is poured, it is not necessary to wait for the concrete to cure completely.
- ! However, you must wait 2 to 3 weeks before filling the pool with water.

Your pool comprises several types of wooden slat, the position of the various types of slat are indicated in the exploded views.

Please note that the 3 x 3 model is fitted with one skimmer and one return fitting

Pool model	Layout of the flat bars along each length	Layout of the flat bars along each width
3 x 3	1700 + 1700	1700 + 1700
3 x 6	1700 + 1570 + 1570 + 1700	1700 + 1700
4 x 8	1700 + 1570 + 1070 + 1070 + 1570 + 1700	1700 + 1070 + 1700

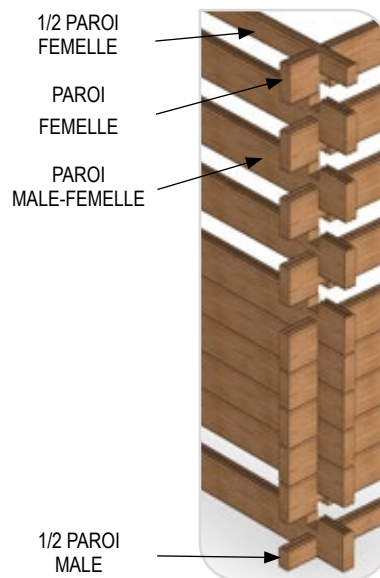

Figure 12 – Assembling the walls

The slats comprising your pool are common to several pool models. For information concerning the lengths of the slats constituting the walls of each pool model, please refer to the table above:

Paint the ends of the slats in the corners with a wood stabiliser to limit deformation over time. This product is white on application, but becomes colourless when dry. Drying time is 2 to 3 hours. Apply a second layer if the temperature is high or if the product dries too quickly. Follow the safety instructions printed on the container. Rinse the brush after use.

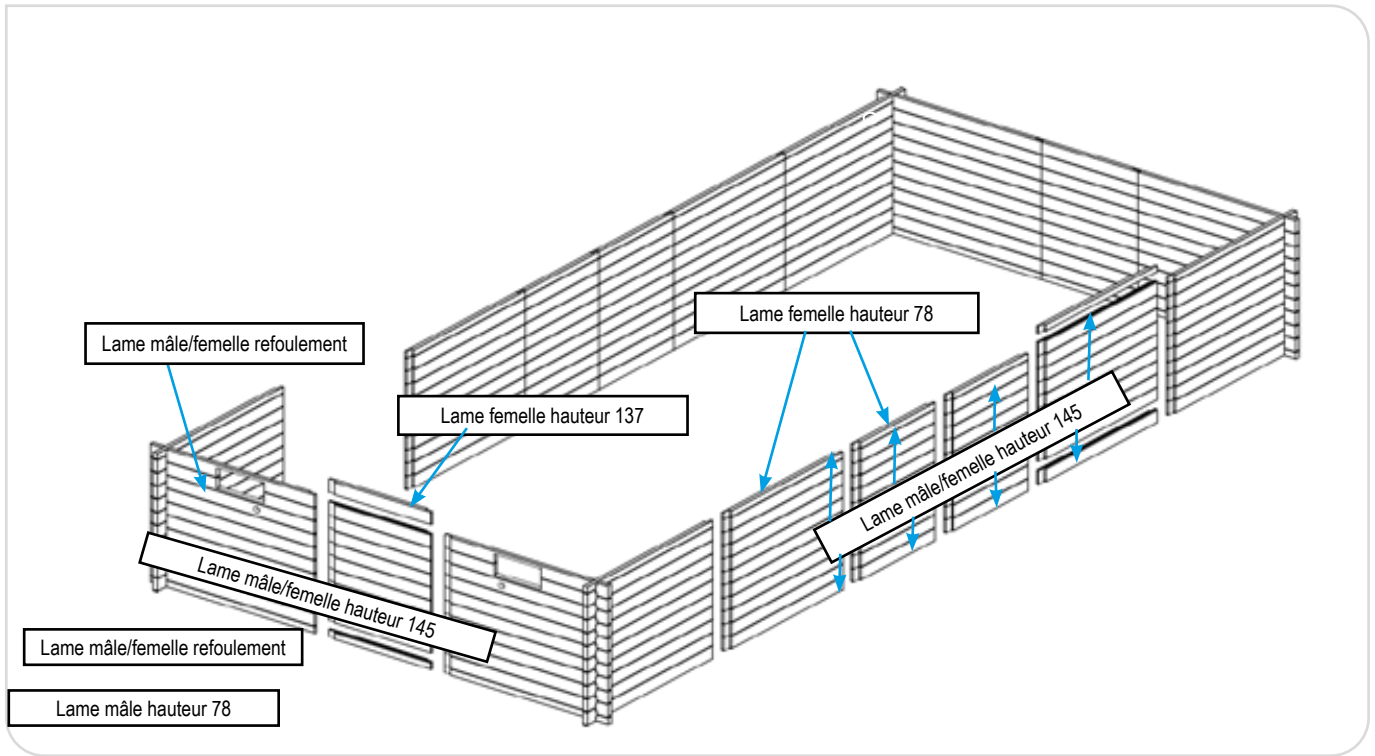

Figure 13 – Layout of the slats by type - WEVA model - 6 x 3

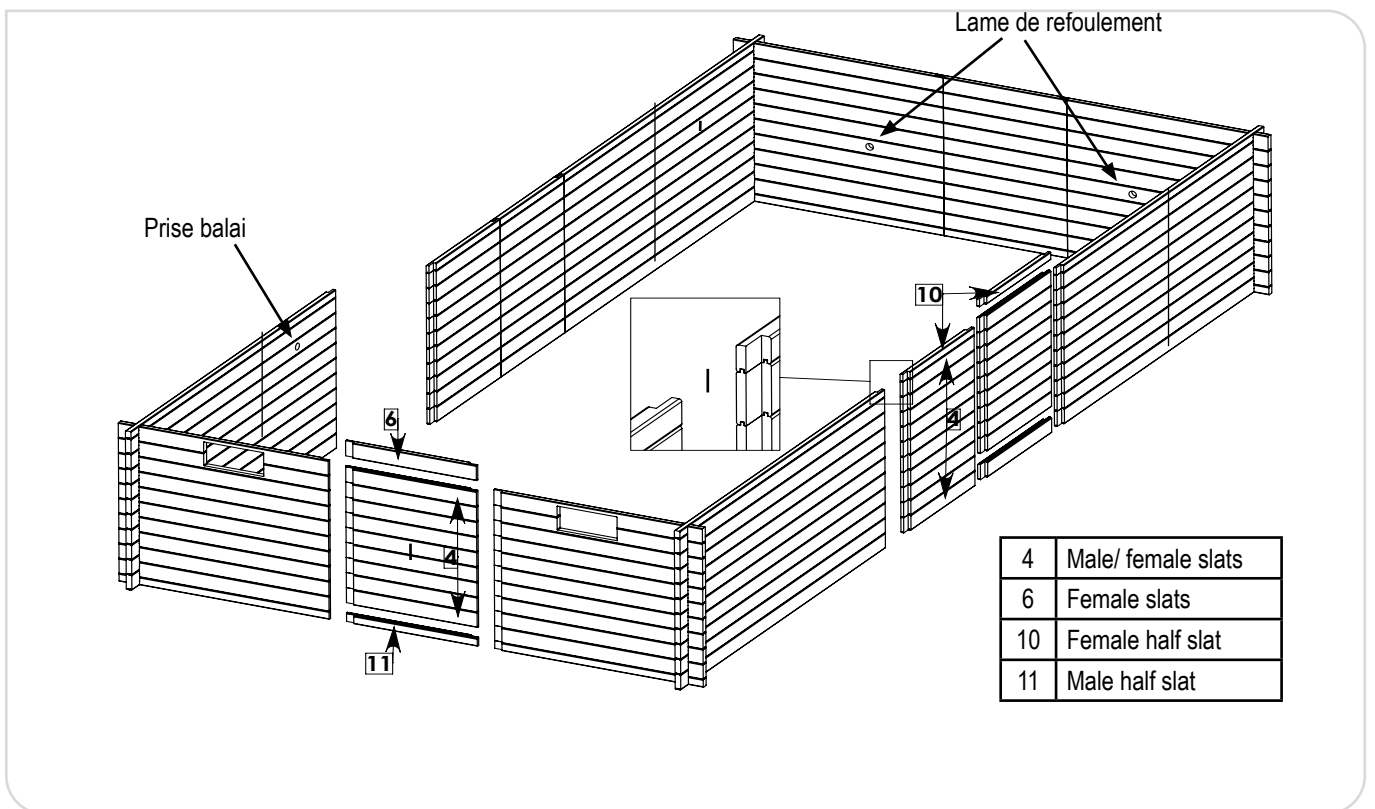

Figure 14 – Layout of the slats by type - ODYSSEA model - 8 x 4

9. THE WALLS (CONTD) & DRESSING THE POSTS

While assembling the slats, make sure as of the beginning that the tongues are fully engaged in the grooves.

Start by unrolling the strips of asphalt (*Figure 15*) that will insulate the wooden structure from the concrete slab.



Figure 15 – unrolling the asphalt strips

Lay out the ½ slats 'ref. 8' that make up the pool widths, then at the corners fit them into the slats marked '1' that make up the pool lengths (*Figure 16*). After positioning the 1st layer of slats, check that the diagonals are equal. Screw the slats together using screws from bag C as shown in (*Figure 16*). Be careful to remove any splinters as you go.

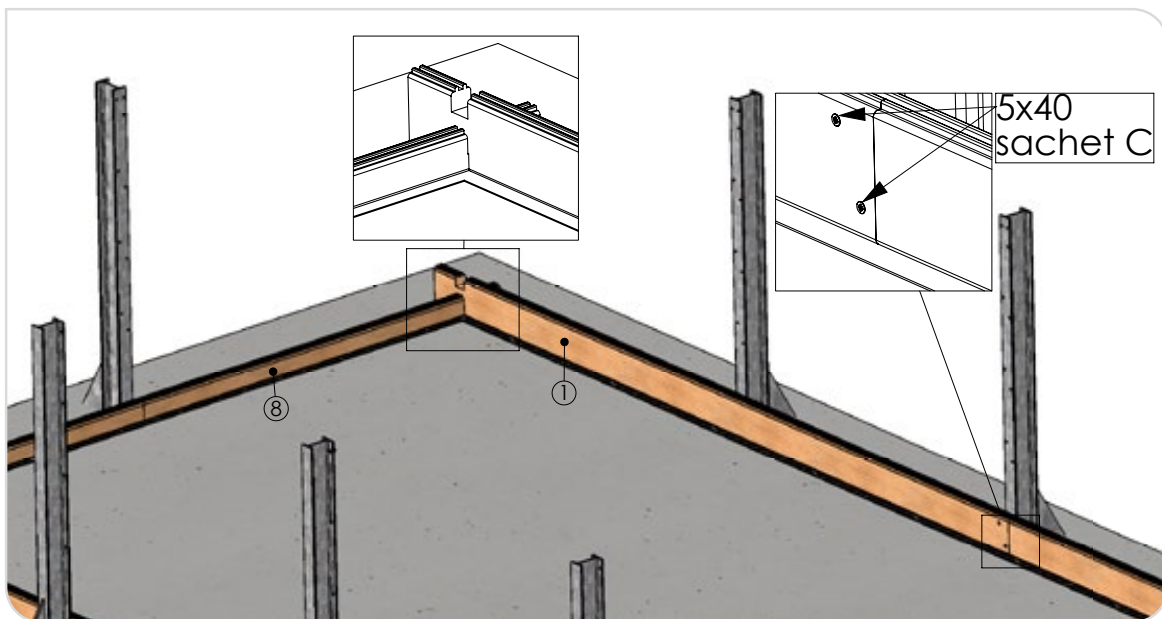

Figure 16 – 1st row of slats

The slats should be fixed to the metallic posts as they are slotted into position (these are pre-drilled) with screws 6x30 from bag D.

Use a hammer and a clamp to gently tap the slats into position if necessary. Do not strike the wooden slats directly, use the protective martyr blocks (supplied). Be careful to ensure that each row of slats is fully engaged before starting with the next.

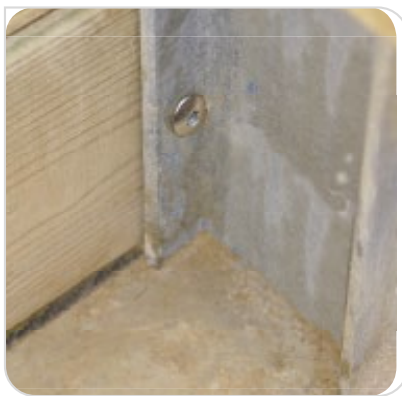

Figure 17 – Detail

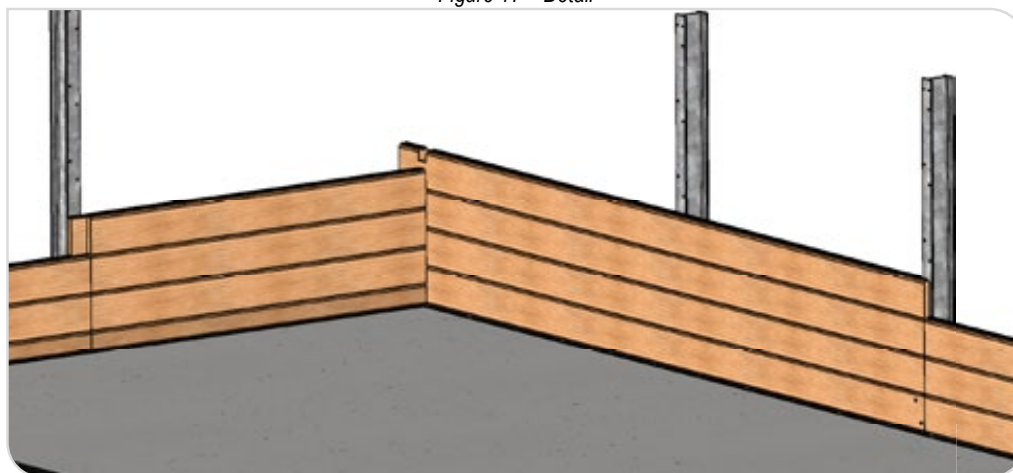

Figure 18 – Assembly of the slat walls

Fit together the remaining slats taking care that the slats machined to receive the pool fittings are in their correct positions.

The slats with the openings for the return fittings should be in the 6th row

The slats machined to take the skimmers should be placed in rows 8 and 9 of 1.20m high pools, rows 9 and 10 of 1.33 m high pools and rows 11 and 12 of 1.46 m high pools.

Cover the metallic posts with the decorative profiles. The profiles should be flush with the top of the wooden wall.

Screw them in place from the inside of the pool as shown opposite. (SS screw 5x80 bag O). The top of the profiles will be screwed together when the coping support fittings are mounted on top of the posts (*Figure 21*).

Eliminate any splinters raised by screwing. Should it be necessary to trim the profiles to size (for example, if the pool is partially in-ground) orient the cut surface facing upwards. The 2 profiles do not meet, the metallic post remains visible.

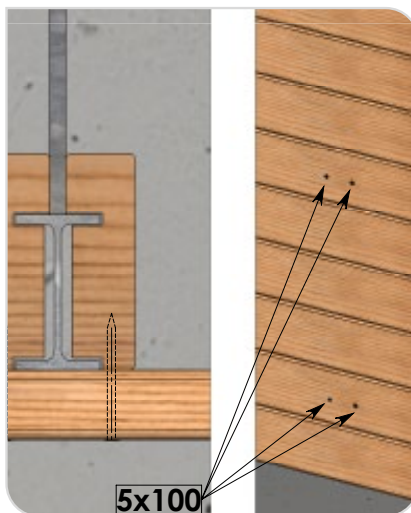

Figure 19 – Fastening the slat to the posts

10. MOUNTING THE COPING SUPPORT BRACKETS

Chamfer the edge of the central holes in the support bracket plates so that they can be correctly screwed into position.

Make sure that the plates are level to facilitate subsequent laying of the coping.

Mount the coping support brackets, on every side, except from the side housing the skimmers(s), position a bracket midway between each two posts as shown in the following illustrations (*Figure 22*). For the position of the brackets across the width housing the skimmer(s), refer to the diagrams (*Figure 22*).

Use the 5x100 SS screws from bag L to fix them in position. The brackets should be positioned 3 mm below the top of the wall (fig19) so that the support bracket plates will be flush with the top of the wall when installed. Before screwing the plates into position, lightly mill the central holes through which the screws (5x40) will be inserted.

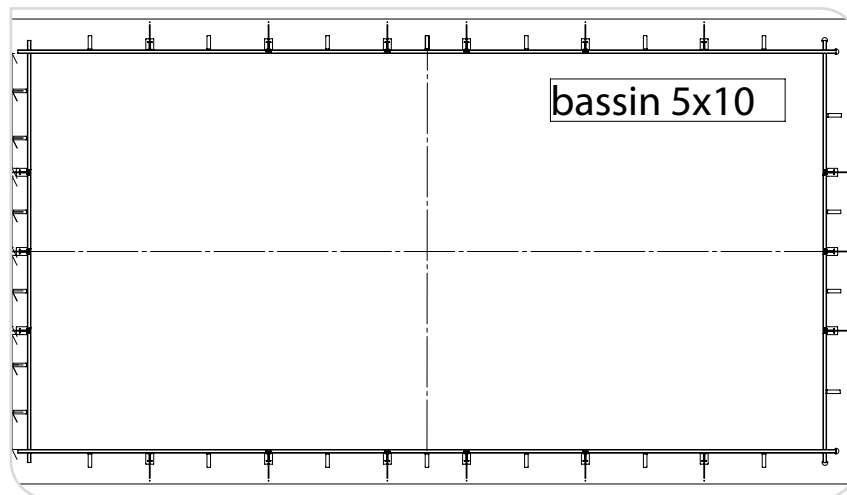

Figure 20 – pool 5 x 10

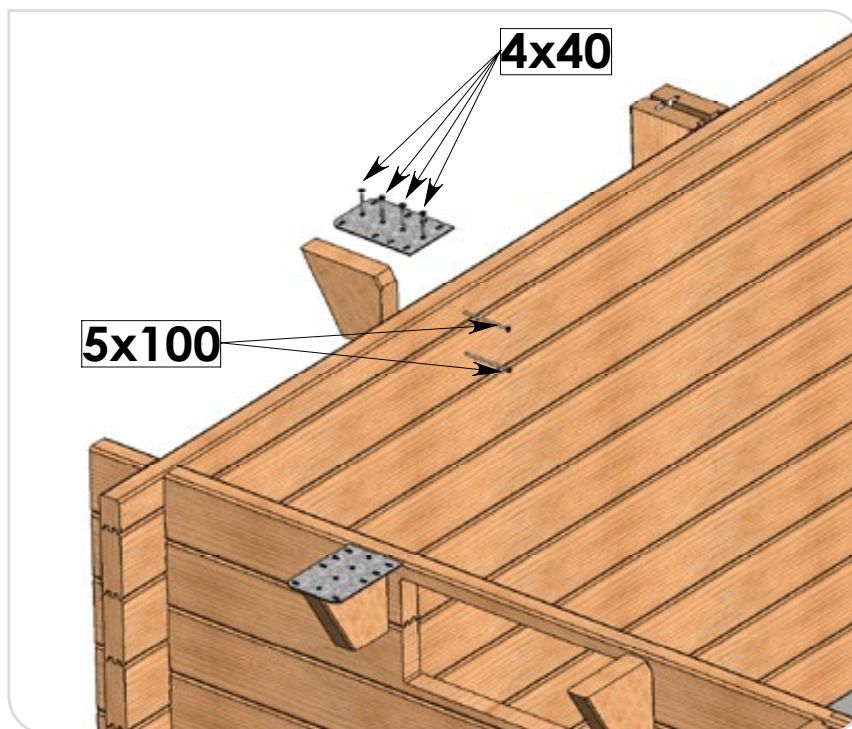
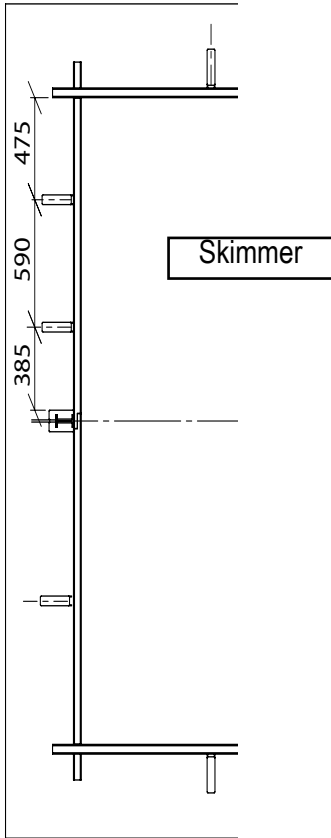
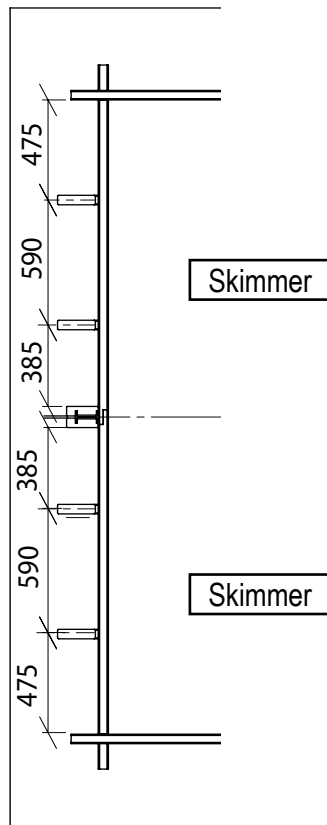

Figure 21 – Coping support brackets

Bassin largeur 3m 1 skimmer



Bassin largeur 3m



Bassin largeur 4m

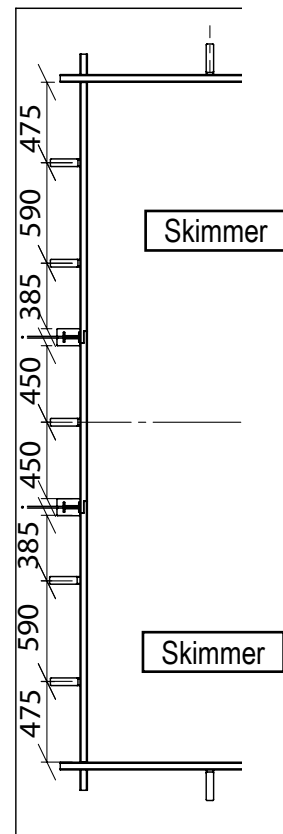

Figure 22 – skimmer positions

11. INSTALLING THE METAL FITTINGS

! The coping support fittings are designed to hold the coping modules and fix them in position.

Fasten the metal fittings that will hold the coping to the top of the posts. Make sure that they are flush with the top slat and that they are aligned with each other and with the support bracket plates along the lengths of the wall.

Use the 6x30 Torx screws from bag D.

Figure 23 – Metal fittings



In the corners, use the remaining left and right fittings and 4 corner brackets.

Figure 24 – Corner brackets

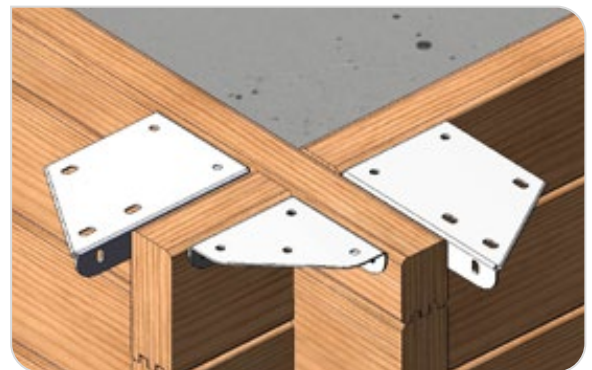

Fix decorative profiles to the ends of each wall using 3 evenly spaced nails from bag I. The decorative profiles should be pre-drilled along their axis.

If you need to trim the profiles, orient the cut side so that it is facing upwards.

Figure 25 – Finishing trim

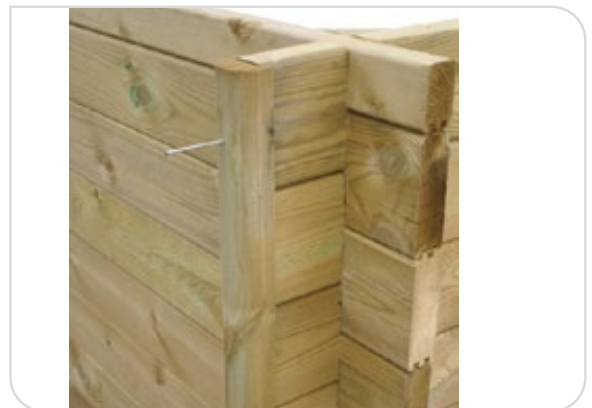

In each corner, mount a wooden triangle to support the liner locking track corner elements. (stainless steel screw 5x40 bag C).

Figure 26 – Wooden triangle



12. MOUNTING THE LINER LOCKING TRACK

! Before beginning to mount the liner locking track, make sure that the structure has been correctly assembled. To do this: use a spirit level to verify that the structure is level around the entire periphery, check that the diagonals are equal in length, correct any imperfections before continuing.

Position 2 liner locking track corner pieces in each corner. (You will find the parts in the liner/waterproofing kit). You will need to trim an interlocking pin off each corner piece. Make sure that the 2 corner parts are level with each other and flush with the top of the wall. A gap of a few mm between the two parts is not problematic. Use 4x35 stainless steel screws from bag H.



Figure 27 – Corner liner locking track

! The track should be perfectly flush with the top of the wall.

! Before fixing the track in position, pre-drill the holes using the Ø 4mm drill bit provided (bag J).

! Remember to deburr the track after making the cuts..

! Take care not to overtighten to ensure that the screws do not break through the track.



Figure 28 – Liner locking track

Continue to mount the locking track using the lengths provided, these should abut the locking track junctions (*Figure 29*).

Insert a screw (stainless steel 4x35 from bag H) at 20cm intervals. Locking track junctions do not necessarily line up with the posts.

Towards the end, it will be necessary to trim the lengths. Cut the length to size between two liner locking junctions then bend the track to allow the junction pins to fit into place



Figure 29 – Locking track junction

13. WALL FINISHINGS

Glue the 8 polystyrene elements (enclosed in the filtration pack) into each corner of the pool. 4 will need to be trimmed to the size of your pool. Use a glue that is compatible with the materials involved.



Figure 30 – polystyrene elements

Cover the vertical joints in the wall with a strip of adhesive tape (roll enclosed in the liner/waterproofing kit), make sure that screw heads are covered.

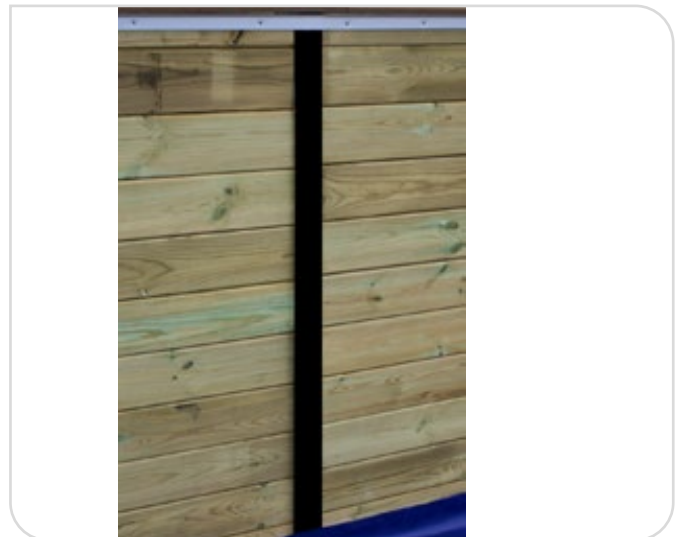

Figure 31 – Adhesive strip

14. INSTALLATION OF THE POOL FITTINGS

- ⚠ When fastening pool fittings in position, avoid overtightening the screws as this could crack the fitting. Hand tighten by preference
- ⚠ Make sure that the gaskets are correctly positioned and applied. It will be difficult to correct mistakes made after the liner is fitted.

14.1 Les skimmers



Figure 32 – Prefix flange

First, mount the skimmer prefix flange using the slotted countersunk head wood screws (VB FZ) 3x25. You will find these components in the Pool Fitting.



Figure 33 – Put the skimmer in position

Attach the grey tube L.325 (see page 25 ref I10) to the body of the skimmer, then, working from outside the pool, put the skimmer in position taking care to position it flat against the prefix flange.



Figure 34 – fasten the skimmer in position

Hold it in place with the pozi countersunk head (TFZ) screws M5x16 + nuts and washers.



Figure 35 – 1st self adhesive flange

Stick the first self-adhesive gasket (Pool Fitting skinpack) to the front of the skimmer. Take care to ensure that the holes line up correctly.

14.2 Throughwall flanges



Figure 36 – Screwing the body in position



Figure 37 – Applying the gasket

Working from inside the pool, fit the throughwall flanges that will hold the return fittings (pool fittings pack) into the pre-drilled apertures. Fasten them in position using the slotted countersunk head wood (VB FZ) 3x25 screws.

Apply a self-adhesive gasket to each throughwall flange.

15. FITTING THE UNDERLAY, LINER & FILLING THE POOL

- ⚠ Before fitting the underlay, make sure that there are no splinters or any other structural asperities that could damage the liner.
- ⚠ The ideal ambient temperature for fitting a liner is between a 18 and 25°. If the liner is fitted in colder weather, take care to store it beforehand in a heated room.
- ⚠ Should the liner need to be repositioned while fitting, never pull it along the rail. Release it and reposition it to avoid the risk of tearing (damage of this type is not covered by the guarantee).
- ⚠ Before and during the filling, check that liner is correctly hung, particularly in the corners. Leave the half pegs in position while filling the pool.

15.1 The underlay

Before spreading the underlay (waterproofing pack) over the concrete, make sure that the surface of the concrete is smooth, flat and clean. The underlay is precut to the pool dimensions, no trimming will be necessary. Once laid, smooth out creases as much as possible.



Figure 38 – the underlay

15.2 The liner

Put the liner pack in the pool (caution: it is heavy!). Take the liner out and unfold it once across the pool and then totally along the length of the pool. Before proceeding with the fitting itself, allow the liner to rest for a while so that it becomes more supple, this will facilitate its installation.

Climb bare foot into the pool, check that the bottom corners of the liner wall are properly aligned with the corners of the pool structure. The liner corners are marked and should correspond with the pool corners. It is important to spread the liner out correctly. Push the upper bead of the liner into the liner locking track, continue the whole way around the periphery of the pool. Hold the liner in place as you go using half pegs (supplied with the liner), particularly in the corners.

With the liner correctly hung in place, fill the pool with 2 cm of water and smooth out any creases pushing them from the centre of the pool towards the pool walls. This will not be possible if the pool is completely empty or too full (more than 2 cm water).

Once creases have been eliminated, continue filling the pool until the water level is 5 cm below the return fitting.



Figure 39 – Fitting the liner



Figure 40 – Hold the liner in position with half pegs

At this point, the filtration group should be installed before continuing to fill the pool.

16. THE FILTRATION GROUP

- ! The pump's power supply must be protected by a differential circuit breaker installed upstream from the installation.
- ! Installation of the filter below the water liner is strongly recommended. Above the water line there is a risk of deformation due to depressurisation. The maximum allowed is level with the coping. In the event that the filter is installed above the water line, a flap valve must be installed on the return line and an easily accessible check valve must be installed on the suction line (these items are available from all pool specialists).

16.1 Installation

A list of the components comprising the filtration system is provided below. You should also refer to the additional instructions enclosed with the filter, pump, skimmer, etc..

The installation described is a standard installation with the filtration group located 3.5 m from the pool as required by the safety standards in effect. You may need to alter the lengths of the tubes to adapt to the configuration of your terrain, the position of your pool (above-ground, partially in-ground or in-ground), the type of plant housing or a number of other installation constraints.

For the installation, refer to the sand filter assembly instructions below and the operating guide enclosed with the pump. Study the diagram of the filtration system that shows the various elements and connections.

- ! The filtration system provided in the kit, and every other electrical device, must be wired in according to the standards applicable in the country of installation.

Do not hesitate to call in a professional to guarantee the compliance of your installation.

16.1.1 Precautions and advice

- Barrel unions (isolating valves) should be tightened by hand only, no tools are required. In fact, excessive tightening can damage the threading or twist the seals leading to leaks.
- Wrap 3 or 4 turns of sealing tape around connections that have no seals.
- Only the collar clamps (cerflex type) need to be tightened with a crosshead.
- Do not over tighten.
- Do not forget the rubber bands designed to cover the collar clamps.

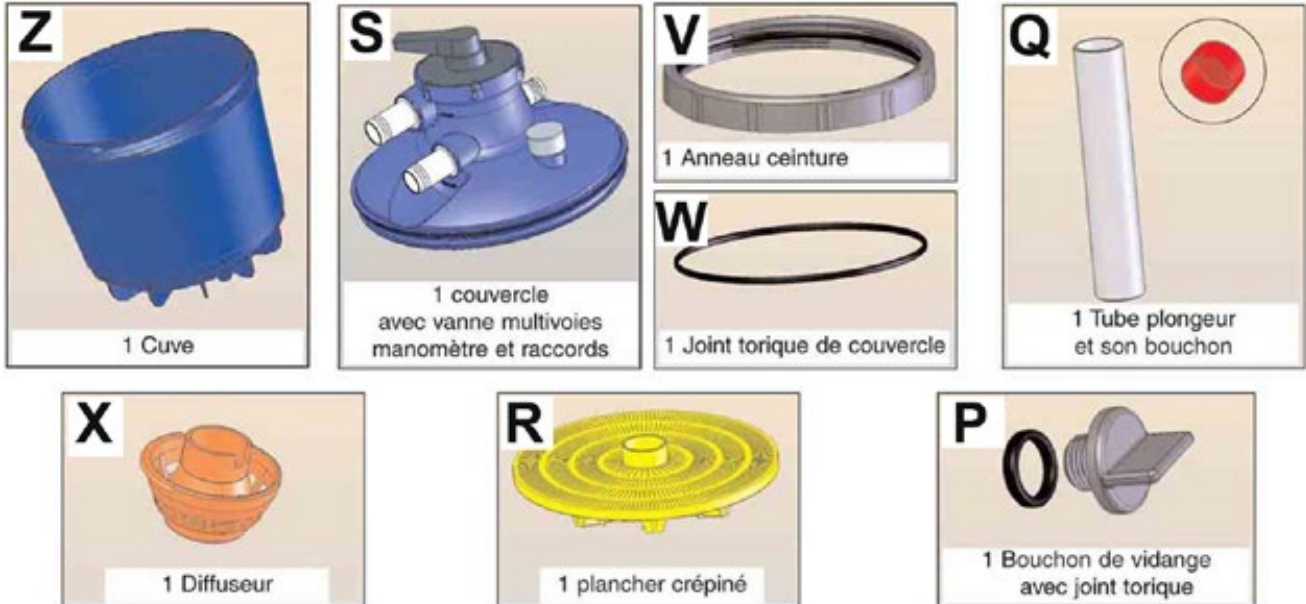

Description	Flow rate (in M/h) no directional jet on the return fitting	Filter diameter (in mm)	Sand	Filtration surface area (m2)	Volume filtered in 24 h
Filtration	7,9	500	3X25 kg	0,2	189,7

Ref	Description	Ref	Description
A	Suction module (rigid descending pipe)	L	Pressure gauge
B	Tube SPI 45	M	Sealing tape (Teflon)
C	Return fitting module (rigid descending pipe)		
D	Rubber band + clamp	O	Return fitting nozzle
E	Pump/ filter connection tube	O1	Return fitting body
F	Suction isolation module (manifold)	O2	Nozzle gasket
G	Pump	O3	Nozzle flange
I	Skimmer	O4	Face ring with adjustable jet
I1	Skimmer lid	P	Drain plug + o-ring
I2	Skimmer basket	Q	Tank collector pipe + plug
I3	Skimmer gasket	R	Collector plate
I4	Skimmer screw 5.5 x 25	S	Lid + 6-way valve
I5	Skimmer flange	T	Filter base
I6	Skimmer weir	U	Pump base
I7	Skimmer flange face plate	V	Lid clamping ring
I8	Skimmer body	W	Lid o-ring
I9	Flow regulator with screw	X	Diffuser
J	Skimmer union	Z	Tank
	Return line isolating module (valve)		



16.2 Mounting the rigid descending pipes

! When assembling the various connections use Teflon and check that o-rings and seals, if any, are in place.

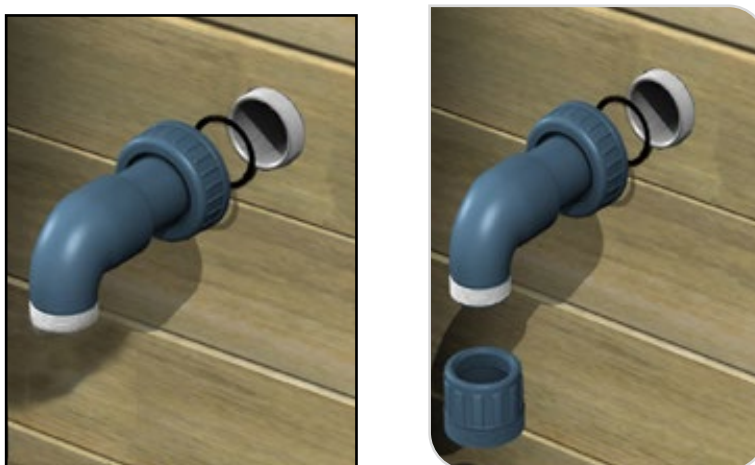

Figure 41 – Elbow on the vacuum fitting - Odyssea model) and Elbow on the return fitting

When mounting the rigid descending pipes, the lower section can be oriented to facilitate subsequent assembly of pipes.

Wrap Teflon 4 or 5 times around the elbows of the rigid descending fittings C (return fittings), screw them onto the exterior outlets of the nozzles, do not forget to use the o-rings provided in the pool fittings skin pack. Tighten by hand to avoid crushing the o-ring.



Figure 42 – Union under the skimmer



Figure 43 – Rigid descending pipe

Next, screw the upper union of the rigid descending pipes, C, onto the 2 return fitting elbows.

Wrap teflon around the 2 threadings on the J unions and screw them into position underneath the skimmer.

Screw the compression union heads into position under the skimmers. Cut the pipes at the mark corresponding to the height of your pool. Chamfer the cut slightly to facilitate insertion of the pipe into the compression union.



Figure 44 – Rigid descending pipe under the return fitting (Odyssea model)

Check that the tube is inserted fully then tighten the green barrel union taking care to ensure that the connection is leaktight.

Screw the rigid descending fittings C onto the return fitting nozzle elbows. Do not forget to check that the o-ring is in position.

Cut the rigid descending pipe under the vacuum fitting, (as indicated above and depending on pool height) and install it

16.3 Assembly of the filter

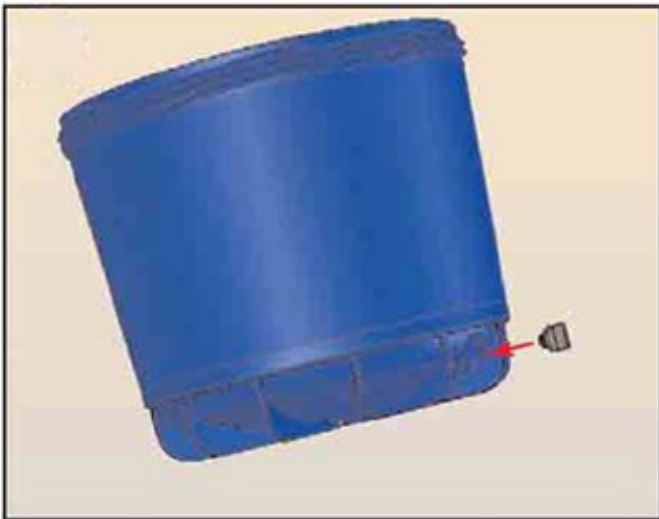

Check that the drain plug and o-ring are in position. Hand tighten only.

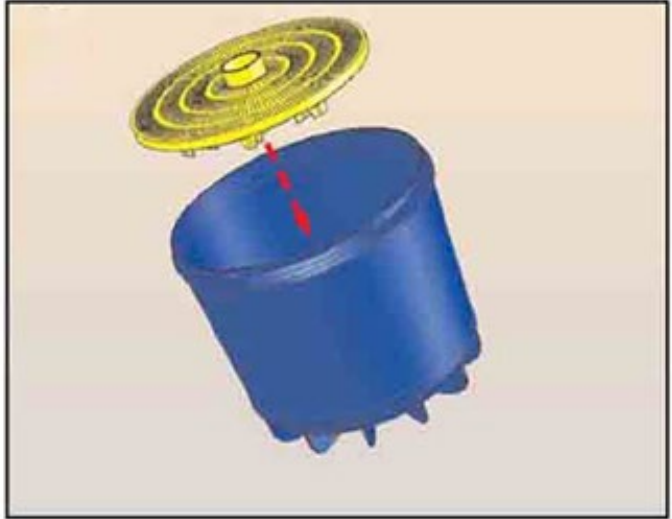

Place the collector plate in the base of the filter tank. Check that it is flat.

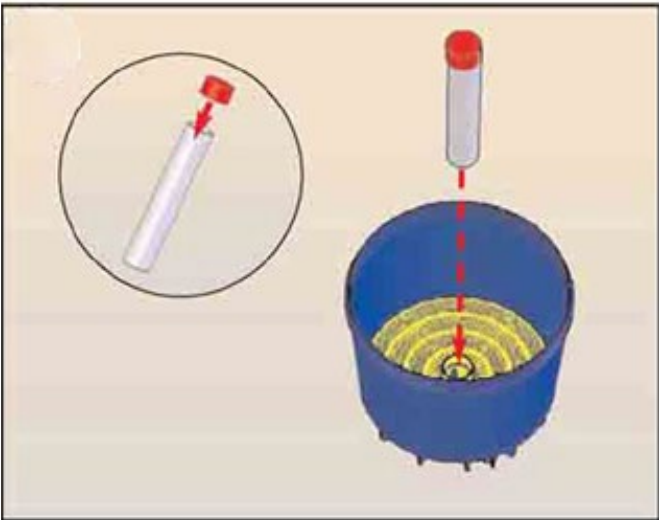

Place the cap on the collector pipe and insert it into the hole in the middle of the collector plate. Pour the sand filter medium carefully into the tank, use your hand to spread it out evenly.

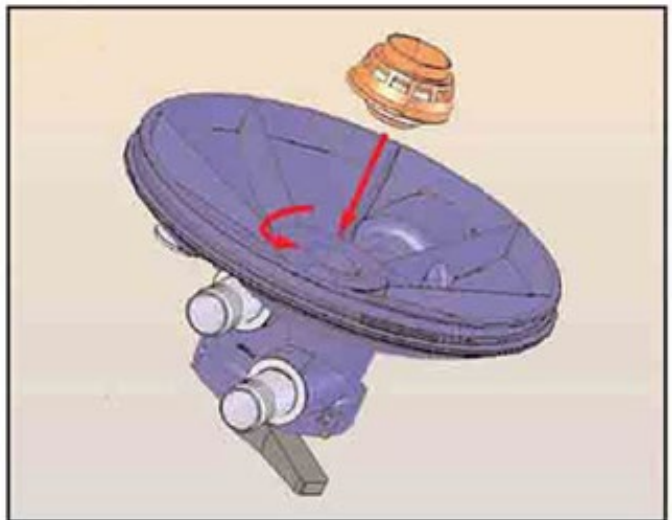

Insert the diffuser into the lid and rotate it anti-clockwise to lock it in position.

The filter lid features 3 ports. Mount the relevant union on each port:

Port on the lid	Union to be mounted
Waste	Hose tail, 38 mm
Suction	Hose tail, 45 mm
Return	Tapped sleeve 1"1/2 x male, solvent, 50 mm.

! The sand should reach 2/3 of the way up the filter.

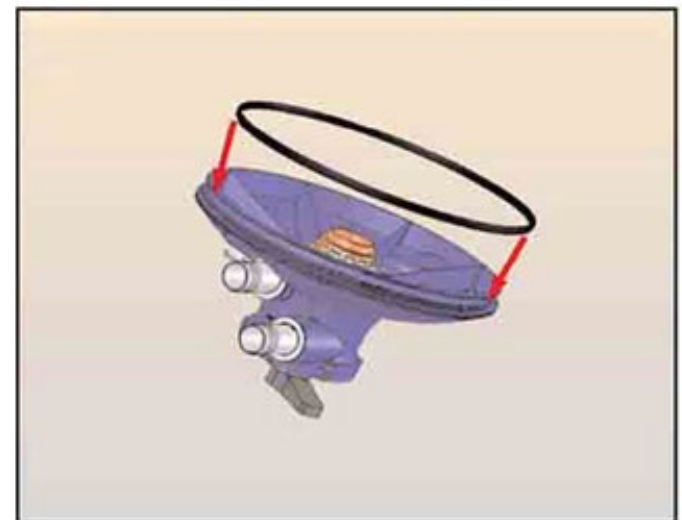

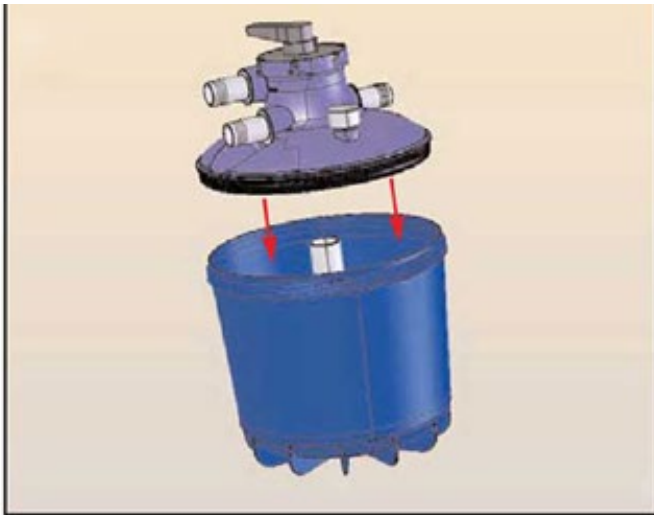

Check that the upper, inner section of the tank is clean.

Remove the cap from the collector pipe.

Apply a lubricant (silicon grease) around the top of the inside of the tank if necessary to facilitate fitting of the lid.

Lay the lid flat on the tank and press down evenly on the lid to insert it into the tank.

Once it is properly fitted the lid should touch the top of the tank and the o-ring should not be visible.



Put the lid ring into position to hold the lid on the tank.

Rotate one quarter turn by hand only.

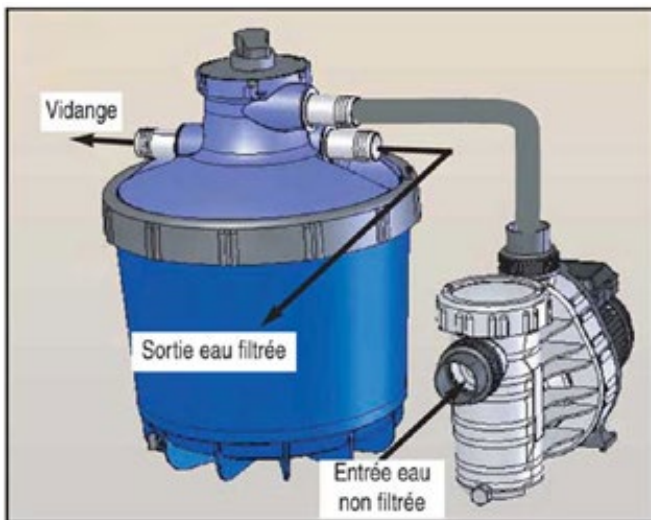

- **!** An improperly fitted lid could lead to:
 - Sand being introduced into the pool through the return fitting
 - Water flowing through the waste port.
 - Water leaks on the tank.
 - It is normal for a small amount of water to flow from the waste port in filtration mode.

Cut the rigid descending pipe on the vacuum point according to the height of your pool and mount it.

16.4 Collector and pump/ filter module

Use silicon grease or soapy water to facilitate fitting of the pipes.



Figure 45 – Collector & pump/ filter module

Before connecting the pipes, make sure that the protective rubber bands intended to cover the Torro clamps after tightening are in position.

Mount the pump on its base, then connect the assembly to the filter base. Ensure that the orientation of the assembly will facilitate subsequent installation of the semi-rigid pipes.

Screw the 3-way manifold (F) onto the pump inlet. Do not forget the o-ring enclosed in the pump pack. Screw the screwed union from the pump pack onto the pump outlet. (Do not forget the o-ring).

Cut a length of tube to size and connect it as illustrated between the pump outlet and the 6-way valve.

16.5 Pipe connections

Connect the rigid descending pipes and the filtration group as illustrated in the diagram below. The filtration kit supplied with your pool is sized for installation of the filtration group 3.5 m from the pool, pipe and tube lengths are indicative. They will need to be modified as a function of your pool configuration. Make sure that you calculate and cut the various lengths as a function of the rolls of tubing provided.

Tip: Use silicon grease or soapy water to facilitate fitting of the pipes.

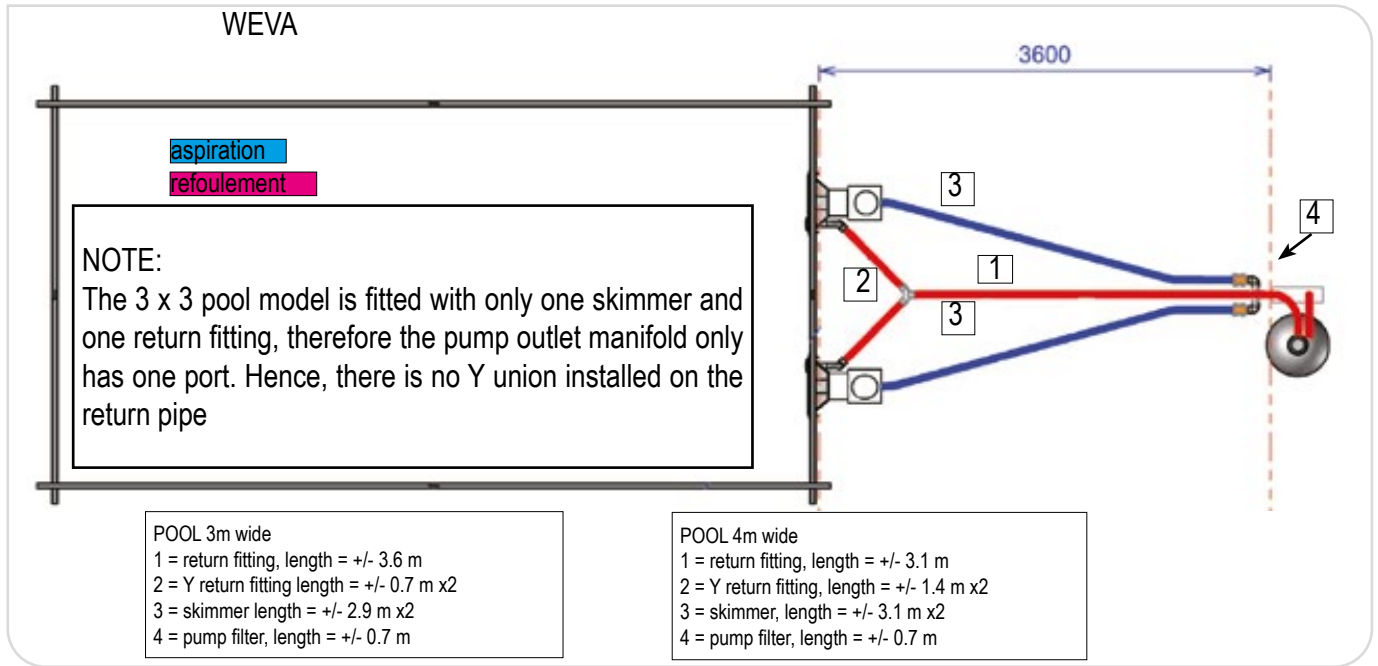

Figure 46 – Example, filtration with two skimmers - Weva

Before connecting the pipes, make sure that the protective rubber bands intended to cover the Torro clamps (connection skin pack) after tightening are in position at both ends.

For models with a single skimmer and a single return fitting, use the 4m ring without cutting it. .

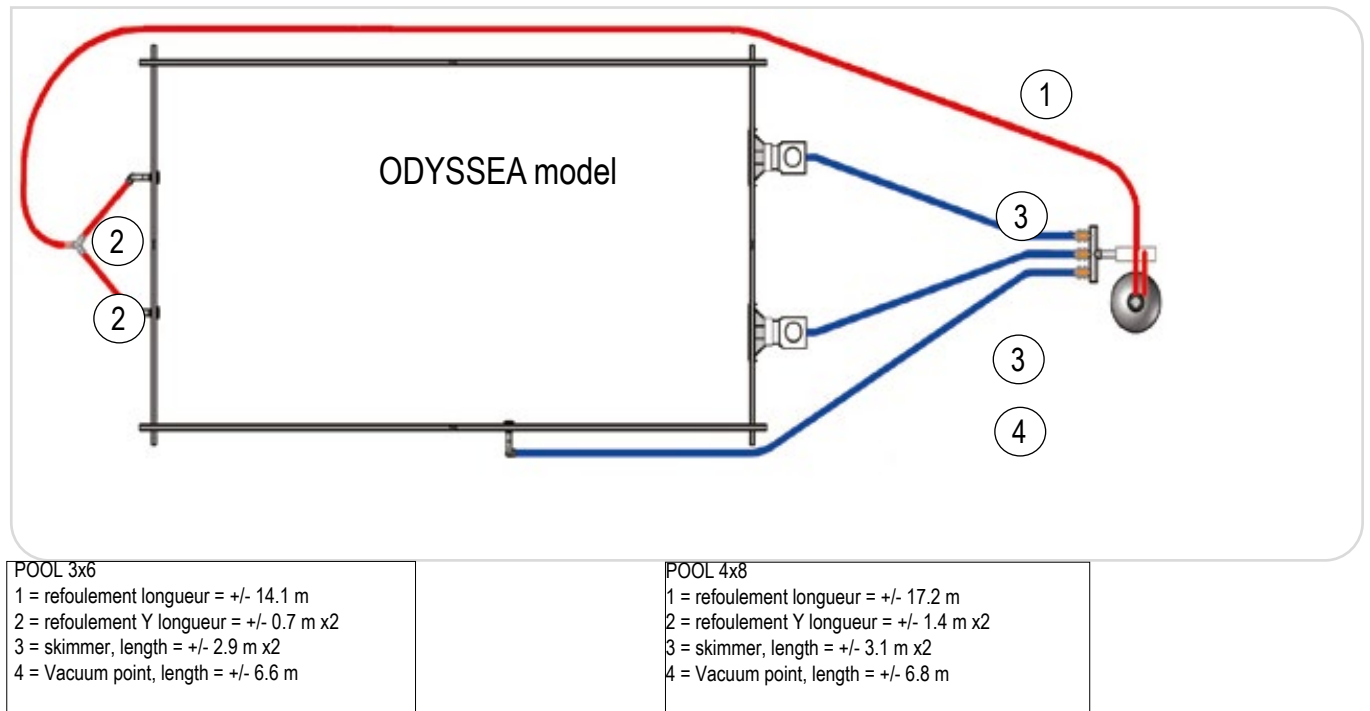

Figure 47 – Odyssea model

Check that all the valves are in their closed positions and continue filling the pool until the water level is 2/3 of the way up the skimmer.

Once all the connections have been made, make the cut-outs in the liner.

16.6 Filling the water circuit

! If the pool is to be installed in-ground, check for leaks before burying the lines and connections.

Open the various valves to fill the hydraulic circuit with water. Check for leaks at the connections.

Before starting the pump (the pump should never be allowed to run 'dry') check that the pre-filter has filled with water. If necessary, open the pre-filter and fill it and the skimmer with water to facilitate priming of the pump.

Turn the 6-way valve to Back Wash (to clean the filter before starting filtration).

16.7 Filling the pool and cutting the liner

! If while filling the pool you note that the liner has been pulled out of the track, stop filling before reengaging it. You may have to partially empty the pool before you will be able to rehang the liner.

! Repositioning of the liner by sliding it along the track is prohibited, this could cause the liner to tear. Release the liner then reposition it.

! Refer to the additional installation instructions provided with the various fittings.

Once the creases on the floor of the pool have been eliminated, continue filling until the water level is 5 cm below the first pool fittings (return fittings). At this point, mark the position of the holes in the pool fittings through the liner and mount the various flanges. Don't forget to apply the second gasket to each flange before screwing it into position.



Figure 48 – Mark the location of the holes



Figure 49 – Apply the gasket to the flange



Figure 50 – Mount the flange

Mark the holes for the screws. Apply the second flange. Screw into position (pozi countersunk head screws TFZ M5x16 from the Pool Fitting skin). Tighten screws alternately and moderately by hand.

Proceed in the same way to fit the skimmer flanges.

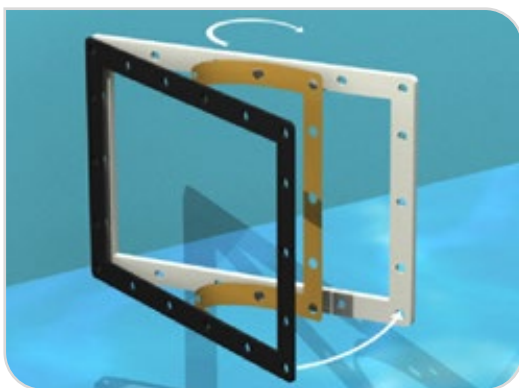

Figure 51 – Apply the gasket to the flange



Figure 52 – Mount the second flange

Next, using a Stanley knife, cut the liner inside the flanges.



Figure 53 – Cut out the liner

16.8 The underwater light (Odyssea model)

To finish installation of the underwater lights, refer to the instructions in the various manuals: Underwater lights & electrical panels.



Figure 54 – Underwater light

Once the underwater lights have been installed, continue filling until the water level is 2/3 up the skimmer mouth.

17. COPING

17.1 Installation of the double pine coping - Weva

Note the arrangement of the various modules comprising the coping on your pool. Orient them with the grooved side facing upwards. Ensure that the modules overlap the pool by about 25 mm (measured from the wall) around the entire periphery. Take time to make sure that the modules are correctly aligned. The gap between the inner and outer modules can vary between 2 and 5 mm.

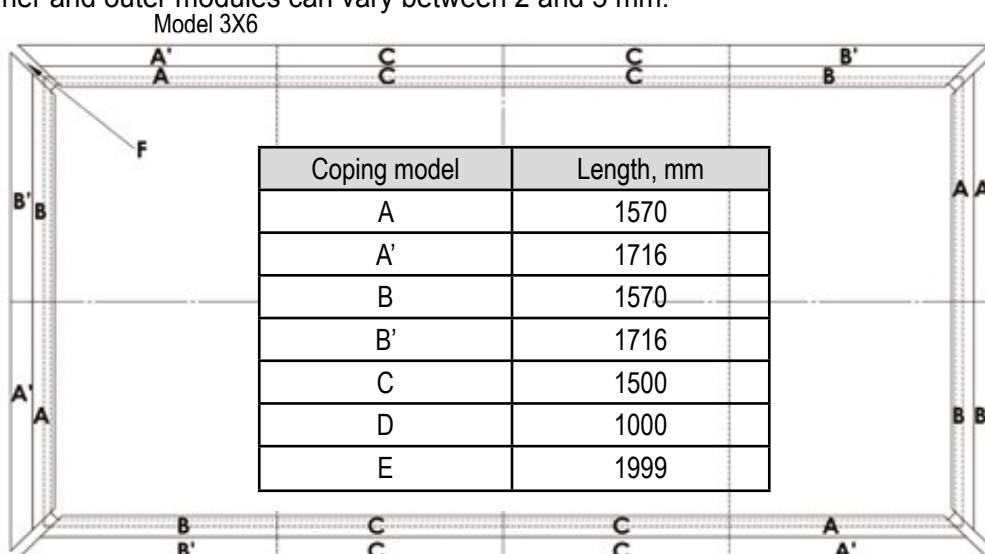

Figure 55 – Coping - Weva 3 x 5

The layout of the coping modules for each pool model is set out in the table below. The coping order is described moving clockwise around the pool.

The length of the coping modules is listed in the above.

Pool model	Position	Layout of the coping module along each length	Layout of the coping module along each width
3 x 3	Interior	A + B	A + B
	Exterior	A' + B'	A' + B'
3 x 6	Interior	A + C + C + B	A + B
	Exterior	A' + C + C + B'	A' + B'
4 x 8	Interior	A + C + E + C + B	A + D + B
	Exterior	A' + C + E + C + B'	A' + D + B'

! Before screwing the parts into position, check to ensure correct alignment and an even overlap around the inner periphery of the pool.

Screw the coping onto the corner brackets, posts and support bracket plates using screws from the bag G inserted through the centre of the slots.

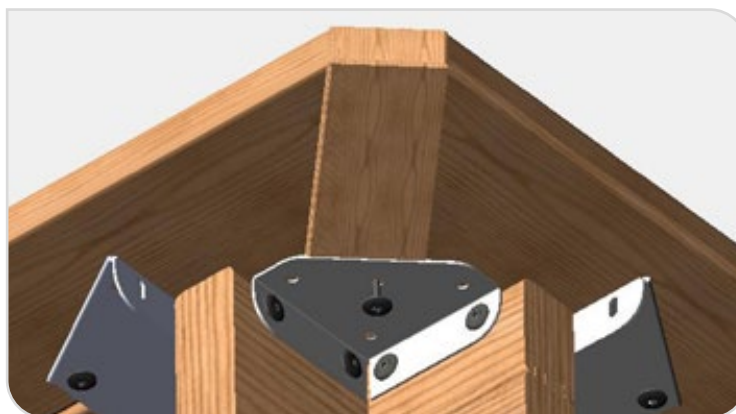

Figure 56 – Corner bracket

Pre-drill before inserting the screws. Use the wood drill bit provided (bag J)..

17.2 Installation of the composite coping - Odyssey

Note the arrangement of the various modules comprising the coping on your pool, put them in position allowing a gap of +/-10mm between the modules and an even overlap (+/- 30mm) over the pool around the entire periphery of the pool. Screw the modules onto the brackets using the 6x20 screw (bag G). Install the junction profiles.

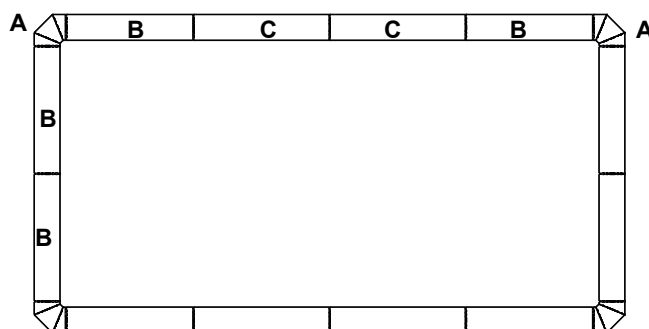

Figure 57 –

Pool 3 x 5

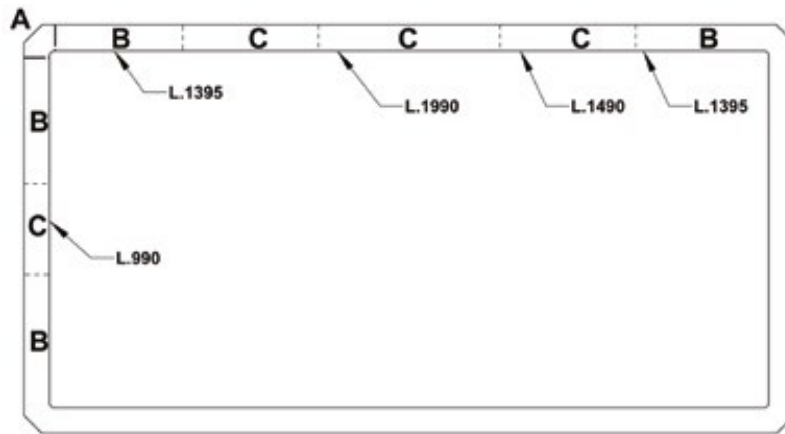
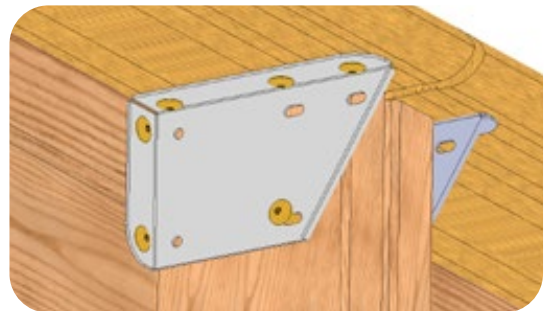
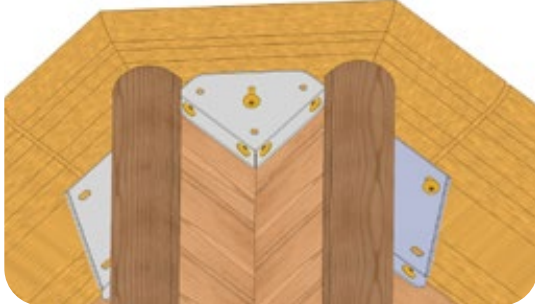
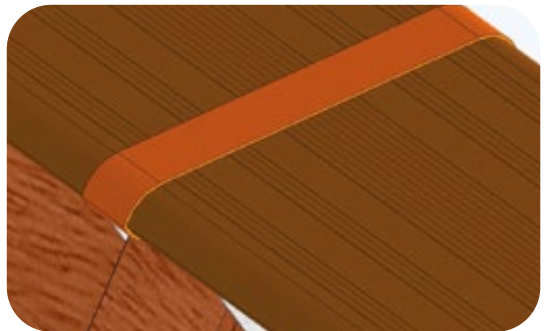
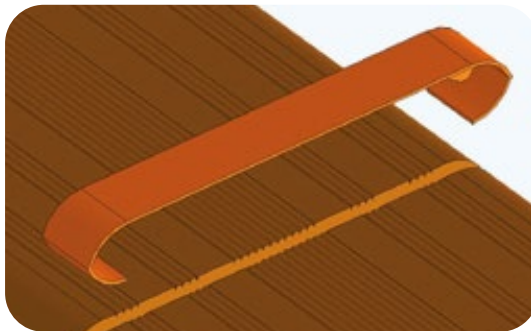

Figure 58 – Pool 4 x 8

! Before screwing the modules into position, check that they are correctly aligned and that there is an even overlap around the inner periphery of the pool.



Screw the coping onto the corner brackets, posts and support bracket plates using screws from the bag G inserted through the centre of the slots. Pre-drill before inserting the screws. Use the wood drill bit provided (bag J).



All the pools are fitted with junction trims to finish the coping. The trims clip over the joints between the coping modules. Bend the trim gently and fit it into position.

18. LADDERS

- ❗ The wooden ladder is a safety element. Do not forget to remove it after bathing!
- ❗ Apply the self-adhesive label recalling this instruction to the wall of the pool!

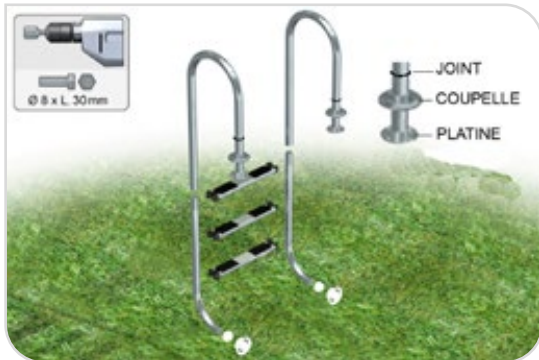

Figure 59 – ladder components



Figure 60 – in-pool ladder

Assemble the various parts of the stainless steel ladder referring to the installation instructions provided. When mounting the handrails, do not forget the two rubber seals that will be used to hold the decorative escutcheon plates in position.

Position the ladder in the pool on the coping module of your choice (but not against the wall holding the skimmer or counter swim module if installed), remember that it should be opposite the wooden ladder.

Adjust the position of the ladder paying particular attention to ensure that it is vertical and that the bumpers are pressed firmly against the inside wall.

Mark the positions for drilling. Remove the ladder and drill.

Fix the ladder in place according to the instructions provided, the counter plate should be positioned under the coping (additional bag in the Filtration pack). Tighten moderately.

Slide the 2 rubber seals along the tubes so that they hold the escutcheon plates in position.



Figure 61 – Assemble the wooden ladder



Figure 62 – Hook beneath the coping

Assemble the wooden ladder as illustrated, use screws from bag (K)

The wooden ladder is held in place by hooks attached under the coping and a lever mechanism attached to the saddle of the ladder. The fastening mechanism may differ from that illustrated but will function according to the same principle.



Figure 63 – Levier



Figure 64 – échelle

19. COMMISSIONING AND OPERATING RECOMMENDATIONS

- The pump power supply must be protected by a 30mA RCD installed upstream from the installation and connected to the electrical panel provided (refer to the installation manual).
- For safety reasons, stop the filtration system while the pool is in use.
- For more information, refer to the manual enclosed with the sand filter.
- The pump should not be allowed to run dry (in the absence of water).
- The pool is designed to be used by persons 3 years of age and older. It is understood that young children and non-swimmers using the pool will wear floatation devices.
- Do not dive.
- Do not step on the coping.
- Never leave an empty pool unprotected.
- Ladders should only be used to enter and exit the pool. Any other use is prohibited and could be dangerous.
- Connect the pump to the electrical panel (refer to the wiring diagrams enclosed with the pump and the electrical panel).

! **WARNING:** Carry out a back wash and rinse before using the filter for the first time to clean the filter and remove any excess sand and impurities (see the paragraph Filter and Valve operation). After the back wash, rinse before turning the valve to the Filtration position. After the back wash, with the multi-port valve set to Filtration, the black needle on the pressure gauge indicates the nominal pressure experienced by the filter. This pressure will vary as a function of the pump flow rate, the static pressure and load losses across the pipes.

To keep a record of this nominal pressure (calibration), adjust the dial of the pressure gauge so that the blue needle aligns with the black needle.

! **IMPERATIVE:** Stop the pump before each manipulation of the 6-way valve. Failure to respect this instruction will result in damage to the filter, the valve and pump and cancellation of the guarantee.

Before starting the pump, make sure that all the 1/4 turn valves are open and that the 6-way valve is set to "Filtration".

19.1 Filter and valve operation

- **FILTRATION:** Water arrives from the pump, passes from the top to the bottom of the filter and is returned to the pool.
- **BACK WASH:** Water passes through the filter from the bottom to the top gathering trapped impurities and carrying them directly to waste. A back wash should be carried out as soon as the needle in the pressure gauge enters the red.
- **RINSE:** Water passes through the filter from top to bottom before being directed to waste (allow approx 30 sec for this process.).
- **CIRCULATION :** Water circulates without passing through the filter.
- **DRAIN:** Water passes from the pool to waste (flocculation, etc.).
- **CLOSED:** No water circulation. Never allow the pump to run while the valve is in this position. Similarly, make sure that the position of the various valves will allow circulation of water before turning the pump on.

19.2 Length of the filtration cycle

The length of the filtration cycle depends on the theoretical time taken for all the water in the pool to pass through the filter. For private pools, the max time allowed for all the water to be recycled is 8 hours.

We recommend the following as a function of water temperature:

- Below 14°C : 5 to 6 hours per day.

- From 15° to 23 °C : 6 to 8 hours per day.
- Above 23 °C : 10 to 12 hours per day.

The higher the bather load and the pool water temperature, the longer the filtration cycle should be. To optimise filtration efficiency, run the filter during the day (between 8:00 am and 9:00 pm) and, more generally, while the pool is in use (one bather pollutes 3 m³ of water).

19.3 Cleaning the pre-filter & filter backwash

After a certain time, a drop in the flow rate at the return fittings will be noted. This is due to progressive clogging of the filter or pump prefilter.

19.3.1 Pre-filter

If the pressure indicated on the pressure gauge falls below the nominal pressure indicated by the blue needle, clean the pump pre-filter:

- Stop the pump.
- Turn the 6-way valve to CLOSED.
- Close the suction and return valves.
- Open the pump pre-filter.
- Remove the basket.
- Use a water jet to remove any impurities.
- Put the pre-filter basket back.
- Put the pre-filter lid back on making sure that the seal is correctly positioned and that there is enough water to prime the pump.
- Move the 6-way valve to FILTRATION.
- Open the suction and return valves.
- Switch the pump on.
- Vent the filter (this should be done each time the pre-filter is cleaned and at least once a week).

19.3.2 Filter

If the pressure indicated by the pressure gauge rise above the nominal pressure, carry out a filter back wash.

- Stop the pump.
- Check the pre-filter and clean it out if necessary (as indicated above).
- Before proceeding with a filter back wash or draining the pool, make sure that the waste pipe (not provided) has been attached to the waste outlet.
- Put the 6-way valve to BACK WASH.
- Turn the pump on.
- Observe the colour of the water in the turbidity sight glass.

CAUTION a few seconds will elapse before cleaning begins (water becomes cloudy).

- As soon as the water runs clear, stop the pump.
- Put the 6-way valve to RINSE.
- Switch the pump on for 20 to 30 seconds, to remove impurities and settle the sand.
- Stop the pump.
- Turn the 6-way valve to FILTRATION
- Switch the pump on.

After a backwash, the pressure in the filter should drop back down to the nominal pressure.

19.3.3 Dechlorinator (Odyssea model)

The dechlorinator allows the user to recover the backwash water, instead of channelling it to waste, for use in the garden, to wash vehicles, etc. To install this option, refer to the manual enclosed with the dechlorinator.

20. OPERATION AND MAINTENANCE

Wood is a living material that works when exposed to humidity and temperature variations, the wood may crack or split. This in no way effects the service life of our products.

The wooden components of this pool are subjected to a Class IV autoclave treatment that complies with standards in effect, they present no danger to people or animals that may come into direct contact with the wood.

Under no circumstances should any wood product be applied to the wood (for example: lazure, micro-porous products, etc.).

Over time, the wood will inevitably get dirty. Clean it once a year with a high pressure jet to remove dirt trapped in the pores of the wood.

Take care to regulate the water pressure to avoid damaging the finish or raising wood fibres.

Inspect the wooden structure regularly (particularly the coping and the steps) and remove any splinters that may appear.

This free-standing pool is delivered as a kit and is not designed to be dismantled.

This pool is designed to be used by persons 3 years of age and older. It is understood that young children and non-swimmers using the pool will wear flotation devices. For your safety and that of your children, we recommend that you read and apply the safety recommendations.

Use of a pool kit implies adherence to safety recommendations outlined in the maintenance and operating instructions

Ladders should only be used to enter and exit the pool. Any other use is prohibited and could be dangerous.

The wooden access ladder should be taken away and stored systematically after the last person leaves the pool. This is to prevent the risk of drowning. We have designed a fast efficient locking system, use it!! Store the ladder in a dry place during the winter. There should be no means of access to the pool while it is not in use. The ladder wood should be maintained in the same way as the other wooden elements.

We recommend that you secure access to the finished pool with one of the measures set out in the French pool safety standard NF P 90-306, 307, 308 & 309 that is: Safety barrier - Alarm - Safety cover - Shelter.

Inspect the accessible nuts and bolts regularly and carry out any maintenance required (re-tighten, treat traces of rust, etc.).

Take care of the liner of your pool, do not treat it roughly. Make sure that correct tension is maintained on the liner, failure to do so could result in tears and leaks. See the guarantee conditions at the end of this manual.

During the life of your pool it may be necessary to empty it completely. In this event, take every precaution necessary to avoid accidents and danger (falls, etc.). Avoid leaving the pool empty for more than 48 hours, this could result in deformation of the structure.

Failure to abide by maintenance instructions may entail serious risks to health and safety, notably of children.

20.1 Winterizing the pool



NOTE: Winterizing is not mandatory, particularly in clement climates where temperatures remain positive year round.

In this case, keep the water at the correct level and run the filter for 2 to 3 hours per day. Check the water level in the pool regularly.

- Carry out a prolonged back wash of the filter.
- The pool should not be emptied during winter (or prolonged periods while the pool is not use). The liquid mass plays a several roles, providing thermal insulation, holding the liner and pool structure in position.
- Lower the water level to about 10 cm below the bottom of the skimmer mouth.
- Water can be siphoned from the pool or allowed to drain by gravity by moving the multi-port valve to DRAIN. Water will run through the waste line. Do not run the pump during this operation.
- Next, disconnect the pipe underneath the skimmer so that it can act as an overflow in the event the water level rises due to precipitation. Remove any water treatment chemicals from the skimmer (chlorine tablets, flocculants, etc.).
- Unscrew the return fitting face ring from inside the pool.
- Use a threaded winterizing plug or rubber plug (not provided) to block the return fitting from inside the pool.
- Add an algicide and a winterizing product (not supplied) to the water.
- Remove the stainless steel ladder.
- Place a winter cover over the surface of the pool (If the pool is fitted with one).

20.1.1 Winterizing the hydraulic installation

- Disconnect the return line.
- Allow water to drain from the suction and return lines.
- Open the plug at the bottom of the filter and allow water to drain away. Do not replace the plug until the filter is being put back into service.
- Open the drain plugs on the pump and pre-filter.
- Leave the plugs open.
- Cut the power supply to the filtration control panel.
- In as far as possible, store the filtration group in a location protected from humidity. In the case of an unprotected outdoor installation, remove the pump and store it.
- We think that we have provided you with main information you require to use and maintain your pool, however you will find more information in specialised guides and reviews. Don't hesitate to consult these.

20.2 Water treatment

To ensure correct usage of your pool, make sure that the water is treated properly. To do this, follow the recommendations pertaining to usage of your filtration group: commissioning, bather load in the context of water regeneration, maintenance and inspection of this system (pipes, bolts, screws). Monitor the build up of impurities in the sand filter (refer to the filter backwash procedure).

Similarly, it is important to check that the filtration ports are not blocked

- Filtration should be stopped during interventions on the filtration system.
- Do not allow access to the pool if the filtration system is not running properly.
- Damaged elements or assemblies must be replaced as quickly as possible.
- Only use parts approved by our after sales service.

During the pool season, the filter should be run every day for long enough to allow the entire pool water volume to pass through the filter at least three times every 24 hours.

To ensure optimal efficiency of the filtration system, make sure that the water level remains correct and constant. The water level should be 2/3 of the way up the skimmer mouth.

To fill your pool, use tap water, its pH is close to the ideal pH. If you use water from a well or some other private source you must have it tested before use. You will need to test the pH of your pool at regular intervals and adjust it if necessary to keep it between 7.2 and 7.6. The necessary treatment chemicals are widely available.

To preserve the quality of the pool water, it will need to be tested and treated regularly. Frequency will depend on a number of conditions; pool situation, bather load, weather conditions, etc. Familiarise yourself with the use of the various pool chemicals that may be necessary to treat your pool.

As backwash water may not be channelled into the sewage system, it must be disposed of in accordance with the regulations concerning disposal of pool waste water in effect in the area in which the pool is located.

20.3 Hygiene

As regards hygiene, there are no official regulations pertaining to family pools. Despite this, for the sake of your own health, and the health of those close to you, there are some rules that you should follow!

This begins with good personal hygiene for the benefit of all. .

Next, to maintain water purity, follow the instructions provided in the paragraph "Operation and Maintenance". Pay careful attention to water treatment cycles, water testing and also filtration and cleaning. You are responsible for maintaining the balance of the water in your pool.

Do not hesitate to keep a log and seek professional advice.

21. GUARANTEES

21.1 Wooden components:

10 year guarantee from the manufacturer against insect infestation and rotting (wood is high pressure autoclaved in accordance with the standards in effect).

This guarantee does not cover natural warping of the wood (appearance of cracks, splits that in no way impact the mechanical strength of the wood) or changes in colour attributable to weathering. Defects resulting from errors in mounting or storage are also excluded from the scope of this guarantee: deformed wall slats (exposure to sunlight, assembly deferred after opening the package), slats altered or broken due to assembly in a manner other than that set out in the installation instructions.

Due to the constant pressure exerted by the water, the pool walls may bulge slightly over time.

This phenomenon, attributable to the natural elasticity of wood, will stabilise of its own accord and will not entail any risk of failure of the wooden slats.

This is not a defect and will not be accepted as grounds for a guarantee claim.

Furthermore, wooden elements to which a product (e.g. lazure, etc.) has been applied will not covered by any guarantee.

21.2 Accessories

According to the conditions of coverage against manufacturing defects and assembly defects of the various accessories comprising the pool and that could impinge upon its correct use. The guarantee conditions stipulate specific periodic inspections and maintenance that must be carried out for the pool to run correctly. The successful outcome of any claim made under the aforementioned guarantee will be contingent on strict adherence to its conditions.

This guarantee does not cover corrosion that may occur over time, nor does it cover damage caused by inappropriate handling during assembly or use of accessories (impacts, scratches, etc) or incidents

not directly related to normal usage of the pool or its accessories. All of these guarantees apply to parts recognised as defective by our services and are limited to replacement of the implicated item(s).

The costs of dismantling and reassembly are not covered.

Guarantee conditions covering items from the accessories kit & optional equipment

Article	Subject and scope of the guarantee	Term of the guarantee as of the date or purchase	Conditions governing acceptance of a claim
Liner	Leaktightness of welds. The guarantee is limited to replacement or repair of the liner recognised as defective without any other damages or interest	2 years against leaks 2 years against stains	Adherence to conditions governing fitting, use and maintenance.

Each component of the accessories kit is guaranteed 2 years.

- ❗ Please retain the notice, invoice, proof of purchase and traceability number listed on the waterproofing and filtration pack.
- ❗ The following problems, associated with inappropriate use or maintenance of the membrane, are not covered in the scope of the guarantee:

Creases that appear after the liner has been fitted, these can be caused by sliding of the membrane on loose soil or an uneven surface, or physico-chemical properties of the pool water that are outside the acceptable ranges: water temperature should be less than 28°C, pH should be between 7.2 and 7.6 and the concentration of the sterilising agent should be within the range recommended by the manufacturer of the water treatment products.

The appearance of yellow stains or discolouration along the water line .

These may be the result of deposition of organic compounds floating on the water surface (sun creams and oils, residue of hydrocarbon combustion or smoke from wood fires). To prevent this from happening, clean the water line regularly using products designed for this purpose (not supplied) and a non-abrasive sponge.

Very hard water can also be the cause of this type discolouration due to the build up of calcium deposits on the membrane. Hard water (TH greater than 225 ppm) should be treated with a product to eliminate calcium and suitable for use in pools (not supplied).

Stains caused by the growth of algae and micro-organisms: the pool water should be treated regularly with an appropriate dose of algacide.

Stains, discolouration and wrinkles caused by direct contact with oxidizing agents (thrown directly into the pool) or pockets of excessively high concentrations of oxidising agents (frequently associated with failure to run filtration during the dissolution phase of the oxidising agents).

Stains caused by stagnation and/or decomposition of a foreign body in direct contact with the liner (dead leaves, oxidizable metallic objects, miscellaneous detritus, etc.)

Damage caused by direct contact with incompatible materials such as bitumen, tar, oils, polystyrene panels, polyurethane. Never apply adhesive tape or glue to the membrane.

Tears that occur while fitting the liner caused by shifting the liner without releasing it from the liner locking track first.

! The following problems, associated with inappropriate use of the filtration components, are not covered under the terms of this guarantee:

Article	Subject and scope of the guarantee	Term of the guarantee as of the date or purchase	Conditions governing acceptance of a claim
Pool fittings	Leaktightness and durability of the pool fittings	10 years	
Filter + connection components	Leaktightness of the filter tank Leaktightness of the pre-assembled connection elements (rigid descending pipes)	5 years on the filter tank	The hydraulic installation, and notably the pump, should generate an operating pressure less than 1.2 bar. Regular back washes to clean the filter to avoid clogging of the filter medium.
Pump	Motor operation Operation and leaktightness of the hydraulic components.	2 years	See below + regular cleaning of the pre-filter

Leaks caused by running the filter at an operating pressure greater than 1.2 bar (use of a pump that is too powerful, clogged filter medium, etc.), or installing the filter above the water level without a vent and check valve. (see the installation instructions)

“stress-cracking” of ABS parts (valve, nuts) caused by surface reactants found in some types of grease: grease should not be used on these types of components.

The continuous expulsion of sand if sand with a grain size of less than 0.6 mm is used (the sand supplied has the correct grain size)..

! The following problems, associated with inappropriate use of the pump, are not covered under the terms of this guarantee:

- Running the pump “dry” (absence of water, clogging of the pre-filter)
- Running the pump without the pre-filter

Article	Subject and scope of the guarantee	Term of the guarantee as of the date or purchase	Conditions governing acceptance of a claim
Summer cover	Integrity of the accessory	2 years	

TIP ! While the cover is not deployed over the surface of the pool, it should be dried and stored away from direct sunlight.

22. DO NOT PLAY WITH SAFETY !!!

Memorise first aid numbers and display them close to the pool.

- Fire brigade:
- Emergency services: 15
- European emergency number: 112
- Poison control centre :(note the number of the closest centre) _____

In this playful context, supervise your children ! Their safety depends entirely on you ! They must be closely and continuously supervised. The risk is at its highest when children are less than 5 years old

- Accidents don't just happen to others. Be ready to act !!
- Never leave a child alone close to the pool.
- Children must be closely supervised at all times.
- Children who don't know how to swim, or children not supervised by adults, should wear a flotation device (vest or arm bands). Without these precautions, access to the pool should be strictly denied.
- The access ladder must be removed while the pool is not in use irrespective of the length of time for which the pool will not be used.
- Designate one person responsible for watching non-swimmers and children.
- Be particularly attentive when there are several people in the pool.
- Keep a pole and/or life ring close to the pool in case of necessity.
- Teach young children how to swim as early as possible!
- Before getting into the pool, wet the back of the neck, legs and arms to prevent irreversible thermal shock! This warning also applies to older pool users who frequently disregard this safety tip.
- Jumping or diving should be prohibited. The same applies to violent games.
- Do not stand or walk on the coping! No diving.
- Be careful not to leave toys in or around an unwatched pool, these could attract children...
- Keep the water clean and sanitary during the pool season.
- Water treatment chemicals should be kept out of reach of children; store them in a safe, inaccessible place. Never leave cleaning accessories near the pool.

SOME EQUIPMENT CAN CONTRIBUTE TO POOL SAFETY:

- safety barrier, with a gate that is always kept closed (for example, a hedge could not be considered a safety barrier).
- a manual or automatic safety cover correctly installed and fixed in position.
- a functional alarm to detect proximity to the pool or falls into the water.

Safety equipment will under no circumstances replace close surveillance.

Outside the pool season, the pool should be covered with a winter cover correctly positioned and attached. This serves an additional function in that it renders the pool less attractive.

Make sure that there is a telephone (land line or mobile) within easy reach of the pool to avoid leaving children alone in the event of a problem.

Learn first aid, especially those techniques applicable to children, to provide assistance in the case of an accident.

Take steps to prevent access to the pool if the filtration system is damaged and during maintenance operations.

In the event of an accident:

- Get the child out of the water as quickly as possible.
- Call for help immediately and follow the advice given.
- Remove the wet clothes and wrap the child in warm blankets.

23. APPENDICES - EXPLODED VIEWS

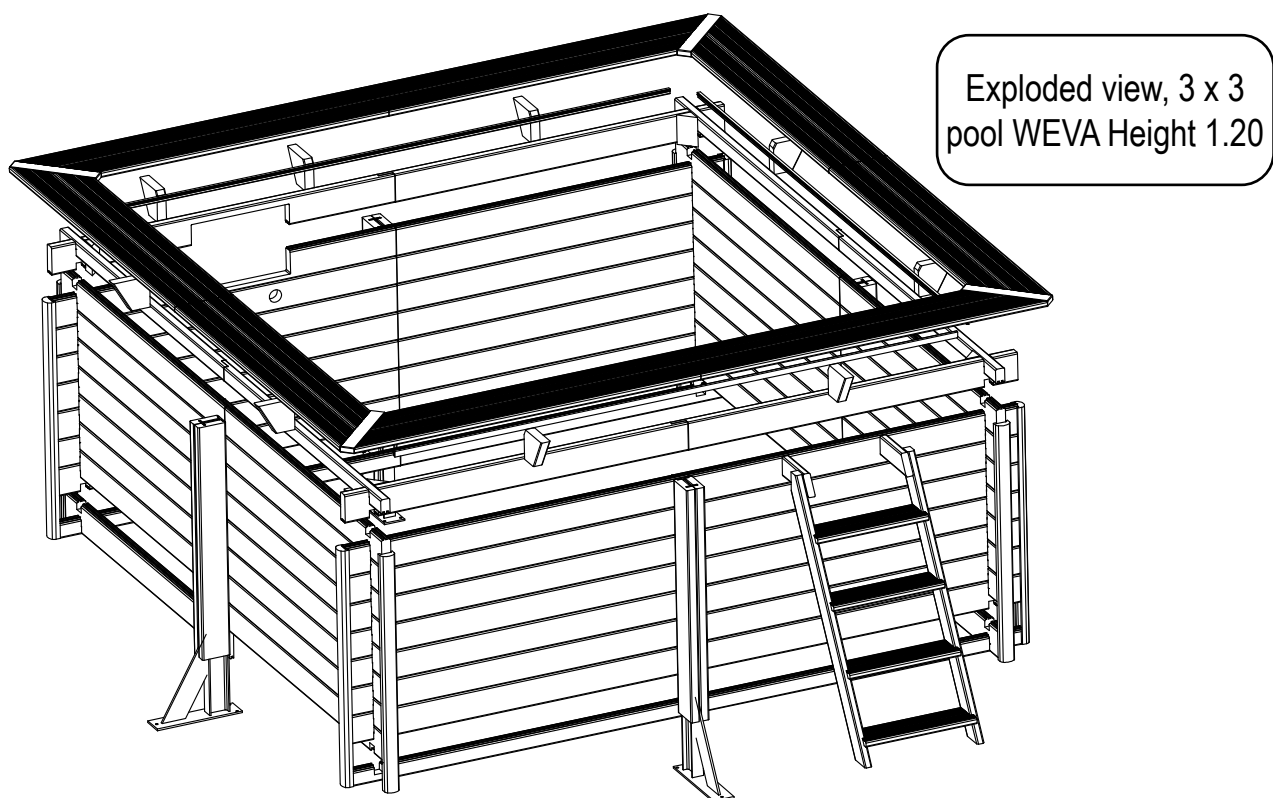

Figure 65 – exploded view, 3 x 3 model- WEVA Height 1.20

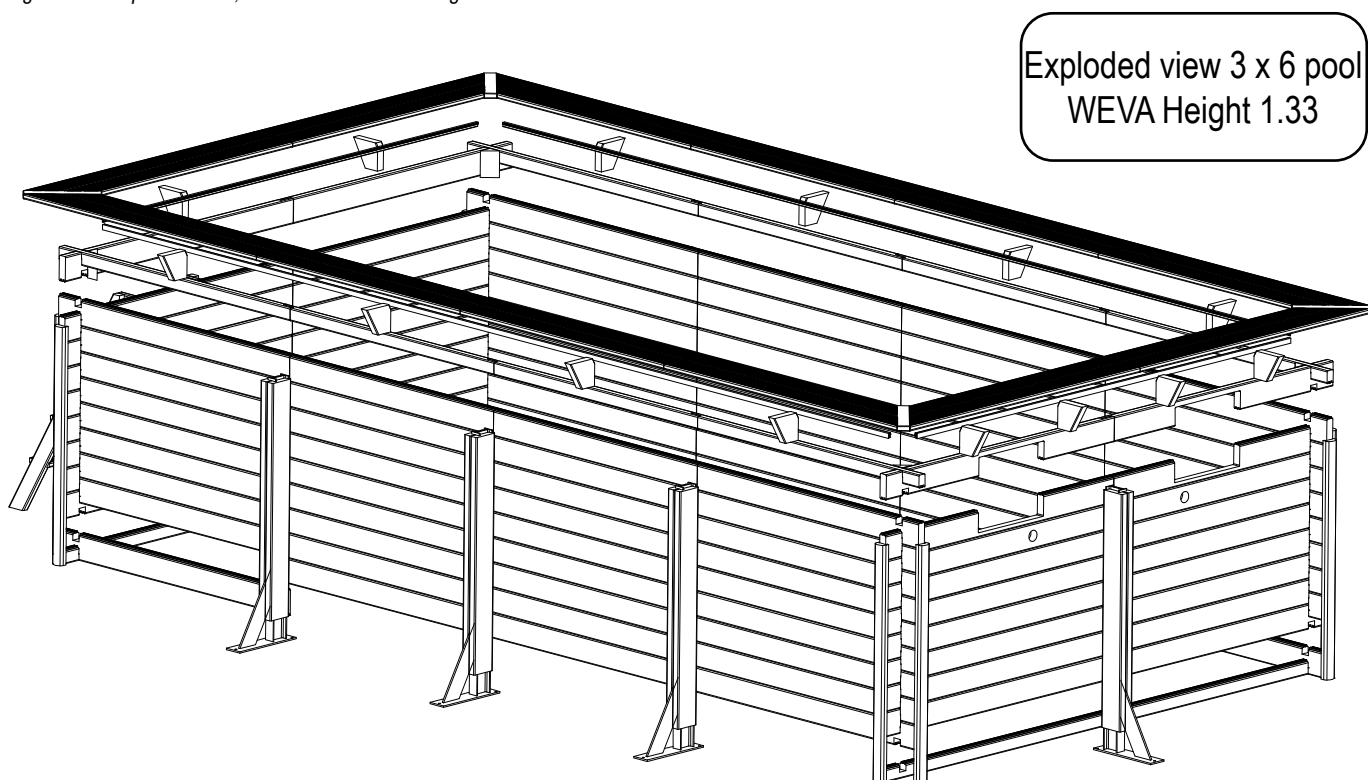

Figure 66 – exploded view 3 x 6 model - WEVA Height 1.33

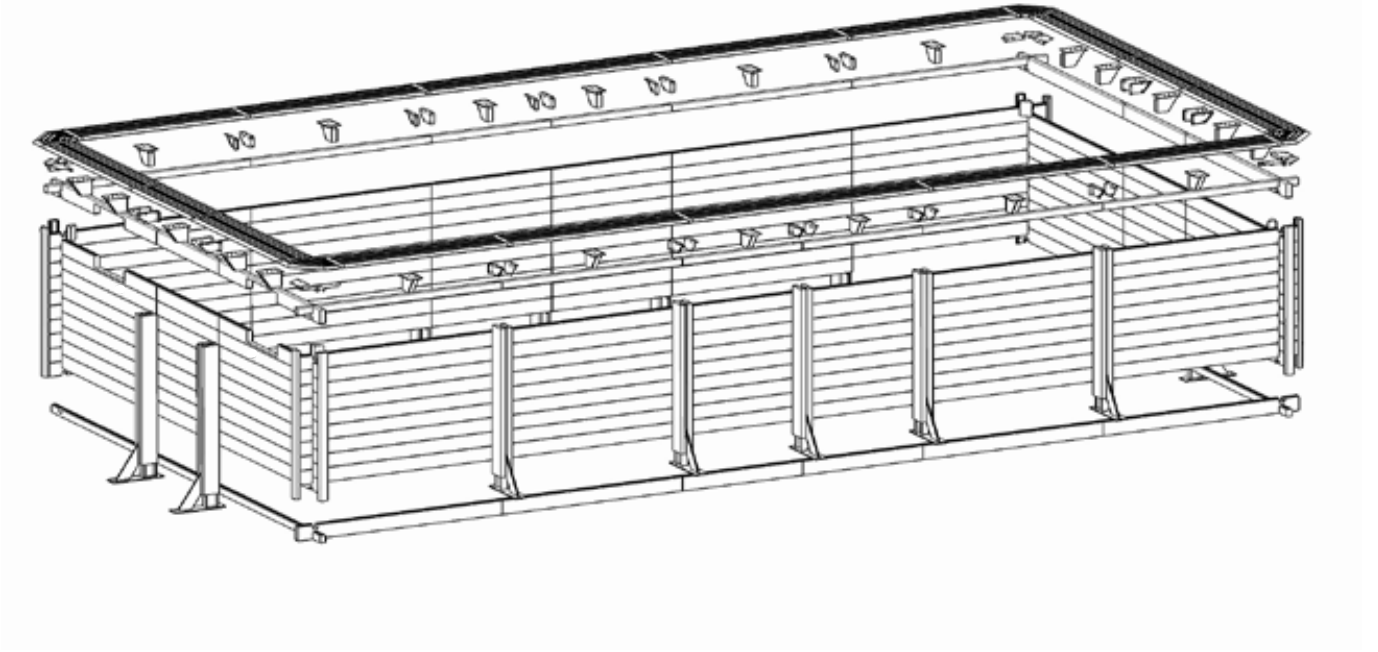

Figure 67 – exploded view 8 x 4 model - ODYSSEA Height 1.46



ATTESTATION DE CERTIFICATION CERTIFICATE OF

CHAÎNE DE CONTRÔLE PEFC CHAIN OF CUSTODY PEFC CERTIFICATION

Société / Company

PROCOPI

35137 - PLEUMELEUC

N° Chaîne de contrôle **FCBA/12-01382**

Chain of Custody Number

Ce certificat atteste la vérification de la chaîne de contrôle PEFC, fondée sur un contrôle permanent.

Il ne peut préjuger d'évolutions ou de décisions qui seraient prises en cours d'année.

La liste des entreprises sous certification est disponible sur le site Internet : www.pefc.org.

This document certifies the certification of PEFC chain of custody, based on a permanent assessment.

There can not be any evolution or decision which would be taken in the course of the year after examination of the results of the audits of follow-up. The update list of the brand's holders and certified products is accessible on the website www.pefc.org.

La chaîne de contrôle de l'entreprise ci-dessus désignée est en conformité avec les exigences PEFC* en vigueur.

The chain of custody of the company appointed above is in compliance with the requirements PEFC in force.

Ce certificat est délivré selon le règlement de gestion de chaîne de contrôle PEFC de FCBA en vigueur.

This certificate is delivered according to the FCBA requirements for the PEFC chain of custody.

Domaine d'application <i>Scope</i>	Méthode utilisée <i>Method</i>	Origine des matières premières <i>Raw materials origin</i>
Fabrication et distribution d'équipements bois pour piscine <i>Manufacturing and distribution of wooden swimming pool equipment</i>	Transfert en pourcentage moyen <i>Average percentage method</i>	Certifié <i>Certified</i>

* annexes 15 et 16 du schéma français de certification forestière 2012-2017, traduction des annexes PEFC ST 2002 : 2013 et PEFC ST 2001 : 2008 du document technique de PEFC C.



ACCREDITATION N°4811
FORTE REPUTE
WWW.COFRAC.FR



10, rue Galilée
77420 Champs sur Marne
Tél : +33 (0)1 72 84 97 84

INSTITUT TECHNOLOGIQUE www.fcba.fr

Pour l'organisme certificateur / For Certification Body

N° de Certificat : 0126/2017

Certificate N° 0126/2017

Date : 2 février 2017

Issued : February 2nd 2017

Valable jusqu'au : 01/02/2022

Valid Until : February 1st 2022

LE DIRECTEUR CERTIFICATION
Anne HOCQUET

2007

Serial number

